



North America



DECEMBER 2014

Price List

www.topconpa.com

 **TOPCON**
Precision Agriculture

Topcon GNSS Accuracy Choices

Pass to Pass Accuracy +/-

30cm*

DGPS

Differential GPS
Frequency L1

Differential Correction
WAAS, EGNOS or VBS

Typical Use

Spraying
Spreading
Harvesting
Mapping
Field Preparation



SGR-1 with TruPass™

GNSS receiver and antenna in a single rugged housing.

or AGI-4

Consistent sub-meter performance with many correction options.

Pass to Pass Accuracy +/-

10cm*

Dual Frequency

High Performance
Dual Frequency HP/XP

Differential Correction
OmniSTAR XP/HP

Typical Use

Planting
Cultivating
Tilling
Seeding



AGI-4

Multiple-constellation. Flexible accuracy options. Standard WAAS and EGNOS, upgradable to RTK, GSM, OmniSTAR.

Pass to Pass Accuracy +/-

2cm*

RTK

Real-Time Kinematic
Dual Frequency L1/L2

Differential Correction
RTK Base Station
NTRIP
CORS/Cell

Typical Use

Strip Tillage
Bedding, Planting
Topographic Mapping
Landforming



AGI-4 or HiPer V Mobile Base Station

Featuring multiple-constellation tracking. HiPer V features Universal Tracking Technology.

* Pass to pass accuracy based on 15 minute intervals.

Accuracy Comparison



Orders must be placed at:

topcon.force.com

Log in to topcon.force.com. If you need a log in, please send an email with your name, contact number, and dealership to: esourcesupport@topcon.com

To contact your Sales Assistant in your Region for questions, please use:

Sales Direct Line: (925) 245-3300

or via email: salesorders@topcon.com

Topcon Positioning Systems

7400 National Drive

Livermore

CA USA 94550

www.topconpa.com

© Topcon Precision Agriculture 2014. All rights reserved.

No portion of this document may be reproduced without the written consent of Topcon Precision Agriculture.



Contents	Page:	
X14	Manual Guidance	5
	Automatic Guidance	6
	Automatic Guidance AES-25	7
	Automatic Guidance 3rd Party Steer Ready	8
	Automatic Guidance Integrated Steering Systems	9
	Automatic Guidance - AGCO Steer Ready	10
	Automatic Guidance - Topcon Full Hydraulic	11
X25	Manual Guidance	12
	Automatic Guidance	13
	Automatic Guidance AES-25	14
	Automatic Guidance 3rd Party Steer Ready	15
	Automatic Guidance Integrated Steering Systems	16
	Automatic Guidance - AGCO Steer Ready	17
	Automatic Guidance - Topcon Full Hydraulic	18
X30	Manual Guidance	19
	Automatic Guidance	20
	Automatic Guidance AES-25	21
	Automatic Guidance 3rd Party Steer Ready	22
	Automatic Guidance Integrated Steering Systems	23
	Automatic Guidance - AGCO Steer Ready	24
	Automatic Guidance - Topcon Full Hydraulic	25
UT Steering		26
GPS Receivers and Options		27-28
AES-25 Adaptor Kits		29-34
Roof Mount Bracket Kits		35-36
Hydraulic Hose Kits		37
X30/X25/GX-45 ASC-10 Sprayer Kits		38
Spreader Control for X25/X30		39
ISOBUS		40
X30 / UT Seeder Interface Kit		41
AgCam X30		42
CropSpec X30/X25		43
X30, X25 and GX-45 Unlock Codes		44
SGIS Software and Subscriptions		45
Water Conservation		46-48
Landforming Survey and Design		49-50
Slope Laser		51
9164 AG System Five		52
9256 AG System Five		53
Spray Control for System 200		54
Seeding Control for System 200		55
Spreader Control for System 200		56
AgCam X20		57
CropSpec X20		58
System 200 Software and Xlinks		59

X14 Manual Guidance



The Topcon X14 precision farming in-cab display is an entry-level guidance console that offers the same look and feel of the innovative and easy-to-use X30 console.

This 4.3" full-color touchscreen offers moving map manual guidance, coverage mapping, or autosteering. It also features an on-screen lightbar. In a later release the X14 will be upgradable to perform both automatic spray rate and section control.

For entry-level manual or automatic guidance, with the convenience and ease-of-use that Topcon touchscreens are noted for, the solution is the new X14 console.

Part Number	Description	USD List Price
X14 Manual Guidance		

1003517-01	KIT, MANUAL GUIDANCE X14	\$ 1,995.00
-------------------	---------------------------------	--------------------



1003517-01 contains:

AGA5498	X14 console
AGA5500	Bracket Kit
AGA5245	Eyelet Power Adaptor
AGA5497	X14/SGR-1 harness
AGA4265	SGR-1 receiver

Options

Power Options:

AGA5259	COBO Power Adaptor	\$ 75.00
AGA5246	AMP Power Adaptor	\$ 75.00
AGA5245	Eyelet Power Adaptor	\$ 75.00
AGA5293	Switched Power Kit	\$ 160.00

Options:

AGA5500	X14 Mounting Bracket Kit	\$ 95.00
AGA5497	Harness X14 to SGR-1	\$ 395.00
AGA5498	X14 Console	\$ 1,195.00
AGM357	Bracket, SGR-1 Roof Mounting	\$ 20.00

X14 Automatic Guidance



This set-up includes the X14 console with the GNSS AGI-4 Receiver / Steering Controller and offers a range of accuracy options for in-field precision. Additional options include steer-ready tractor kits, aftermarket hydraulic kits, and AES-25 electric steering system. The on-screen display can be viewed in heads-up, north-up and perspective modes.

The X14/AGI-4 combination is a complete integrated steering solution featuring multiple-constellation GNSS satellite reception, state-of-the-art inertial sensors and full terrain compensation.

Part Number	Description	USD List Price
X14 Automatic Guidance		
1003518-01	KIT, AUTOMATIC GUIDANCE X14	\$ 5,500.00
	<i>1003518-01 contains:</i>	
	<i>1003561-01 AGI4 Boxed, No Modules</i>	
	<i>AGA5498 X14 Console</i>	
	<i>AGA5500 X14 Mounting Bracket Kit</i>	
1003641-01	Harness Kit X14 to AGI-4	\$ 495.00
	<i>1003641-01 kit contains:</i>	
	<i>AGA4651 CAN Adaptor Deutsch to Turck</i>	
	<i>AGA5245 Eyelet Power Adaptor</i>	
	<i>AGA5480 HRNS X14 AUTO-GUIDANCE</i>	

GPS Receivers and Options

Refer to Page: **27-28**

Options

Power Options:

AGA5259	COBO Power Adaptor	\$ 75.00
AGA5246	AMP Power Adaptor	\$ 75.00
AGA5245	Eyelet Power Adaptor	\$ 75.00
AGA5293	Switched Power Kit	\$ 160.00

Remote Engage:

AGA5079	Remote Engage Kit	\$ 160.00
---------	-------------------	-----------

Options:

AGA5500	X14 Mounting Bracket Kit	\$ 95.00
AGA5497	Harness X14 to SGR-1	\$ 395.00
AGA5498	X14 Console	\$ 1,195.00
1003989-01	Harness GX-45 to X14	\$ 550.00
AGA5428	Harness, AGI-4 Modem Adaptor	\$ 510.00
AGA4903	Harness, Adaptor AGI3 to AGI4	\$ 400.00

X14 Automatic Guidance AES-25

X14 Automatic Guidance AES-25 USD List Price

1003518-01 KIT, AUTOMATIC GUIDANCE X14 **\$ 5,500.00**



1003518-01 contains:
 1003561-01 AGI-4 Boxed, No Modules
 AGA5498 X14 Console
 AGA5500 X14 Mounting Bracket Kit

1003641-01 Harness Kit X14 to AGI-4 **\$ 495.00**

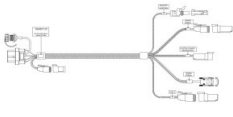

1003641-01 kit contains:
 AGA4651 CAN Adaptor Deutsch to Turck
 AGA5245 Eyelet Power Adaptor
 AGA5480 HRNS X14 AUTO-GUIDANCE

AGA3856 AES-25 Electric Steering Wheel **\$ 3,895.00**



AGA3856 Kit contains:
 A3494 CAN EXTENSION 3 METRES (10ft)
 A3763 ELEC STEER SYSTEM MODULE
 A3819 ASSY AES-25 PWR STEER JCTN BOX
 A3821 HRNS, ELEC STEER PWR STEER
 AGA3873 ELEC STEER JNCTN BOX MNTG BRKT
 A3825 ELEC STEER WHEEL LOGO CAP
 Y1071 CAN TERMINATOR F/MALE TURCK

Note: Select one Bracket Kit and an Adaptor Kit:

Adaptor Kits

Refer to Page: 29-34

Bracket Kits

Refer to Page: 35-36

GPS Receivers and Options

Refer to Page: 27-28

Options



AGA5296 AES-25 Wheel Angle Sensor Kit **\$ 750.00**

AGA5296 Kit contains:
 A3671 Wheel Angle Sensor & Brackets + AGA5376 Harness for AES-25 WAS

AGA4124 AES-25 TRANSFER KIT **\$ 950.00**

AGA4124 Kit contains:
 AGA3873 Junction Box Mount + A3819 Junction Box
 + A3821 Pow Hrns + A3494 3m CAN Hrns + Y1071 Terminator

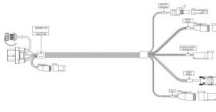
X14 Automatic Guidance 3rd Party Steer Ready

X14 Auto Guidance 3rd Party Steer Ready		USD List Price
 <p>1003518-01 Kit, Automatic Guidance X14</p> <p><i>1003518-01 contains:</i></p> <p>1003561-01 <i>AGI-4 Boxed, No Modules</i></p> <p>AGA5498 <i>X14 Console</i></p> <p>AGA5500 <i>CAN Adaptor Deutsch to Turck</i></p>	<p>\$ 5,500.00</p>	
 <p>1003641-01 Harness Kit X14 to AGI-4</p> <p><i>1003641-01 kit contains:</i></p> <p>AGA4651 <i>CAN Adaptor Deutsch to Turck</i></p> <p>AGA5245 <i>Eyelet Power Adaptor</i></p> <p>AGA5480 <i>HRNS X14 AUTO-GUIDANCE</i></p>	<p>\$ 495.00</p>	
 <p>AGA5249 Kit, ACU-1 Generic Adaptor</p> <p><i>AGA5249 kit contains:</i></p> <p>A3601 <i>ACU-1 ASSEMBLY COMPLETE</i></p> <p>A3626 <i>SYSTEM 150 CONSOLE POWER HARNESS</i></p> <p>Y004 <i>CABLE TIE 380mm x 4.8mm BLACK</i></p> <p>Y1073 <i>CAN TERMINATOR MALE TURCK</i></p> <p>Y1091 <i>CAN TEE F/MALE-F/MALE-MALE</i></p>	<p>\$ 1,400.00</p>	

Note: Select one Steer Ready Kit and suitable Bracket

Steer Ready Kits	Bracket Required
AGA5145 Kit, CIH 10/20/30 SERIES COMB STEER READY	D \$ 1,100.00
AGA5141 Kit, CIH MX / T8000 ENCODER STEER READY	D \$ 550.00
AGA5142 Kit, CIH MX / T8000 TRANSDUCER STEER READY	D \$ 1,100.00
AGA5139 Kit, CIH PUMA / T7000 STEER READY	D \$ 1,100.00
AGA5143 Kit, CIH STX / T9000 ENCODER STEER READY	D \$ 1,100.00
AGA5144 Kit, CIH STX / T9000 FLOW SWITCH STEER READY	D \$ 1,300.00
AGA5138 Kit, JD 6X30/7X30/8X30 NON ILS STEER READY	M \$ 1,100.00
AGA5137 Kit, JD 7X30/ 8X30 ILS STEER READY	M \$ 2,000.00
AGA5135 Kit, JD ARCTIC 9020 / 9030 STEER READY	M \$ 1,300.00
AGA5080 Kit, RAVEN SMARTRAX STEER VALVE (Hirschmann Connectors)	M \$ 1,100.00
AGA5158 KIT INTERFACE TO AUTOFARM HYD VALVE	M \$ 1,100.00

Bracket Kits

Refer to Page: 35-36

GPS Receivers and Options

Refer to Page: 27-28

X14 Automatic Guidance Integrated Steering Systems

X14 Automatic Guidance Integrated Steering Systems

USD List Price

1003518-01

Kit, Automatic Guidance X14

\$

5,500.00



1003518-01 contains:

1003561-01 AGI-4 Boxed, No Modules

AGA5498 X14 Console

AGA5500 X14 Mounting Bracket Kit

Note: Select one Steer Ready Kit and suitable Bracket

Steer Ready Kits

Bracket Required

AGA5027	Kit, CIH 8800 STEER READY	Note: Requires 1003989-01	E	\$	1,500.00
1003871-01	KIT JD R SERIES SYSTEM X14 AGI-4 VEHICLE		K	\$	1,995.00

Unlock code must be purchased from John Deere dealer

John Deere models covered:

6105R, 6115R, 6125R, 6130R, 6140R, 6150R, 6170R, 6190R, 6210R

On ALL 6R models tractor TEC and TEI controller software versions 6.20 or above is required

7200R, 7215R, 7230R, 7260R, 7280R

7210R, 7230R, 7250R, 7270R, 7290R, 7310R

8235R, 8260R, 8285R, 8310R, 8335R, 8360R, 8310RT, 8335RT, 8360RT

8245R, 8270R, 8295R, 8320R, 8345R, 8370R, 8320RT, 8345RT, 8370RT

9360R, 9410R, 9460R, 9510R, 9560R, 9460RT, 9510RT, 9560RT

Bracket Kits

Refer to Page: **35-36**

GPS Receivers and Options

Refer to Page: **27-28**

X14 Automatic Guidance - AGCO Steer Ready

AGCO X14 Automatic Guidance Steer Ready Kit

USD List Price

1003518-01 Kit, Automatic Guidance X14 \$ **5,500.00**



1003518-01 contains:

1003561-01 AGI-4 Boxed, No Modules

AGA5498 X14 Console

AGA5500 X14 Mounting Bracket Kit

Harness Kit Options

1004631-01 KIT X14 AGCO SR GENERIC ECONOMY *Note: Does Not Suit Fendt* \$ **750.00**

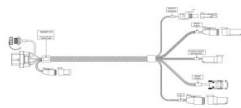

1004631-01 kit contains:

1001006-01 AGI-4 to AGCO Amphenol Roof Harness

1004077-01 X14 to AGCO Steer Ready Cab

AGA5245 Eyelet Power Adaptor

AGA5404 KIT FENDT COM3B SYS 350 AGI4 VEHICLE STD *Note: Suits Fendt* \$ **650.00**

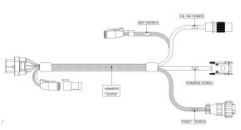

AGA5404 kit contains:

AGA5370 Cab Harness, suits Com3B Fendt for X family consoles

AGA5329 Receiver serial crossover harness to suit Fendt / AGI-4

AGA5403 Hardware Accessory Kit to suit Fendt Install

Cab Harness Accessories

AGA5246 AMP STYLE CONVENIENCE PLUG POWER ADAPTER \$ 75.00

Note: Connects to power separation connector on Gen2Lite harnesses for alternative source of sys power

AGA5259 COBO STYLE CONVENIENCE PLUG POWER ADAPTER \$ 75.00

Note: Connects to power separation connector on Gen2Lite harnesses for alternative source of sys power

AGA5293 ROCKER SWITCH, SWITCHED POWER KIT \$ 160.00

Note: Works with AGA5245 Eyelet harness to provide simple rocker switch power for console startup/shutdown

Bracket Kits

Refer to Page: **35-36**

GPS Receivers and Options

Refer to Page: **27-28**

Optional Harnessing Accessories

AGA5428 AGI-4 EXTERNAL MODEM ADAPTER \$ 510.00

Note: Exposes AGI-4 Serial port for external modem connection for receiver

1004094-01 FENDT RTK ANTENNA RELOCATION BRACKET KIT \$ 200.00

Note: For high gain antenna only

Note: Relocates AGI-4 RTK antenna to side of roof for Fendt Tractors where receiver is recessed into cab roof



1003989-01 SYSTEM 150 KIT TO X14 ADAPTER \$ 550.00

Note: Easy upgrade from existing System 150 harnessing already installed to adapt to X14

AGA4903 AGI-3 TO AGI-4 ADAPTER HARNESS \$ 400.00

Note: Easy upgrade from existing AGI-3 roof harness to adapt to AGI-4

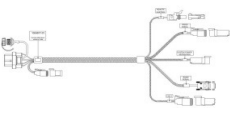
X14 Automatic Guidance - Topcon Full Hydraulic

X14 Automatic Guidance - After Market Hydraulic Kit		USD List Price
1003518-01	Kit, Automatic Guidance X14 <i>1003518-01 contains:</i> 1003561-01 <i>AGI-4 Boxed, No Modules</i> AGA5498 <i>X14 Console</i> AGA5500 <i>X14 Mounting Bracket Kit</i>	\$ 5,500.00
		
1003641-01	Harness Kit X14 to AGI-4 <i>1003641-01 kit contains:</i> AGA4651 <i>CAN Adaptor Deutsch to Turck</i> AGA5245 <i>Eyelet Power Adaptor</i> AGA5480 <i>HRNS X14 AUTO-GUIDANCE</i>	\$ 495.00
		
AGA5249	Kit, ACU-1 Generic Adaptor A3601 <i>ACU-1 ASSEMBLY COMPLETE</i> A3626 <i>SYSTEM 150 CONSOLE POWER</i> Y004 <i>CABLE TIE 380mm x 4.8mm BLACK</i> Y1073 <i>CAN TERMINATOR MALE TURCK</i> Y1091 <i>CAN TEE F/MALE-F/MALE-MALE</i>	\$ 1,400.00
		
AGA5134	Kit, After Market Hydraulic <i>AGA5134 kit contains:</i> A3223 <i>Hydraulic Block w/15 LT Valve</i> A3671 <i>Wheel Angle Sensor</i> AGA3813 <i>Harness, ACU1 to Hydraulic Block</i> AGA3831 <i>Harness, Isolation Valve Adaptor</i> AGA3950 <i>Harness, ACU1 Power</i> AGM383 <i>Generic WAS Bracket</i>	\$ 5,000.00

Note: Select one Hydraulic Hose Kit and suitable Bracket

Hydraulic Hose Kits

Refer to Page: 37

Bracket Kits

Refer to Page: 35-36

GPS Receivers and Options

Refer to Page: 27-28

X25 Manual Guidance



The X25 is latest addition to the Topcon X-Family consoles. The X25 Console is designed to offer full-featured precision machine control and high-accuracy autosteering for smaller cab environments or the more price conscious producer. It is available with feature packages that provide flexibility for virtually any size operation.

The X25 allows adoption of precision farming practices into more operations to lower input costs, increase machine automation, and enable higher operational efficiency.

Part Number Description

USD List Price

X25 Manual Guidance

1005347-01	KIT, X25 SGR-1 Base Kit	\$	4,495.00
-------------------	--------------------------------	-----------	-----------------



1005347-01 kit contains:

<i>AGA4395</i>	<i>Kit, X25 TPA AM</i>
<i>AGA4265</i>	<i>SGR-1 receiver</i>
<i>1005509-01</i>	<i>Harness X25/X30 to SGR-1</i>
<i>AGA5245</i>	<i>Eyelet Power Adaptor</i>

Options

Power Options:

AGA5259	COBO Power Adaptor	\$	75.00
AGA5246	AMP Power Adaptor	\$	75.00
AGA5245	Eyelet Power Adaptor	\$	75.00
AGA5293	Switched Power Kit	\$	160.00

Options:

AGA4395	X25 TPA AM Console Boxed	\$	3,495.00
1005476-01	Unlock Code X25 Advanced Features	\$	2,000.00
AGM357	Bracket, SGR-1 Roof Mounting	\$	20.00

X25 Automatic Guidance



The 8-inch X25 console is designed to offer full-featured precision machine control and high-accuracy autosteering for smaller cab environments or the more price-conscious producer.

The X25 features the same farmer-friendly on-screen navigation menus, drag-and-drop mini-views and user configurable dashboard as its larger sibling, the Topcon X30. Plus, it runs on Topcon Horizon software, now on all Topcon X-Family consoles

Part Number	Description	USD List Price
X25 Base Kit		
1005348-01	KIT, X25 AGI-4 GEN 2 BASE <i>1005348-01 kit contains:</i> AGA4395 <i>Kit, X25 TPA AM</i> 1003561-01 <i>AGI-4</i>	\$ 7,500.00
1003933-01	KIT, X25/X30 Gen2Lite Universal <i>1003933-01 kit contains:</i> AGA4651 <i>CAN Adaptor Deutsch to Turck</i> AGA4700 <i>HRNS GENERIC AGI-4 ROOF EXTENSION</i> AGA5245 <i>Eyelet Power Adaptor</i>	\$ 750.00

GPS Receivers and Options

Refer to Page: **27-28**

Options

AGA4395	X25 TPA AM Console Boxed	\$ 3,495.00
1005476-01	Unlock Code X25 Advanced Features	\$ 2,000.00
1005089-01	Kit VDC and Universal Bracket <i>1005089-01 kit contains:</i> 1003393-01 <i>VDC Controller</i> 1004112-01 <i>Harness VDC CAN/Power</i> AGA5486 <i>Kit, Mounting Bracket for VDC Controller</i>	\$ 650.00
<i>Power Options:</i>		
AGA5259	COBO Power Adaptor	\$ 75.00
AGA5246	AMP Power Adaptor	\$ 75.00
AGA5245	Eyelet Power Adaptor	\$ 75.00
AGA5293	Switched Power Kit	\$ 160.00
<i>Remote Engage:</i>		
AGA5079	Remote Engage Kit	\$ 160.00

X25 Automatic Guidance AES-25

X25 Auto Guidance AES-25 Kit USD List Price

1005348-01 KIT, X25 AGI-4 GEN 2 BASE **\$ 7,500.00**



1005348-01 kit contains:
 AGA4395 *Kit, X25 TPA AM*
 1003561-01 *AGI-4*

1003933-01 KIT, X25/X30 Gen2Lite Universal **\$ 750.00**

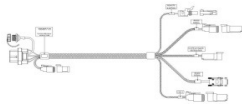

1003933-01 kit contains:
 AGA4651 *CAN Adaptor Deutsch to Turck*
 AGA4700 *HRNS GENERIC AGI-4 ROOF EXTENSION*
 AGA5245 *Eyelet Power Adaptor*

AGA3856 AES-25 Electric Steering Wheel **\$ 3,895.00**



AGA3856 Kit contains:
 A3494 *CAN EXTENSION 3 METRES (10ft)*
 A3763 *ELEC STEER SYSTEM MODULE*
 A3819 *ASSY AES-25 PWR STEER JCTN BOX*
 A3821 *HRNS, ELEC STEER PWR STEER*
 AGA3873 *ELEC STEER JNCTN BOX MNTG BRKT*
 A3825 *ELEC STEER WHEEL LOGO CAP*
 Y1071 *CAN TERMINATOR F/MALE TURCK*

Note: Select one Bracket Kit and an Adaptor Kit:

Adaptor Kits

Refer to Page: 29-34

Bracket Kits

Refer to Page: 35-36

GPS Receivers and Options

Refer to Page: 27-28

Options



AGA5296 AES-25 Wheel Angle Sensor Kit **\$ 750.00**

AGA5296 Kit contains:
 A3671 *Wheel Angle Sensor & Brackets + AGA5376 Harness for AES-25 WAS*

AGA4124 AES-25 TRANSFER KIT **\$ 950.00**

AGA4124 Kit contains:
 AGA3873 *Junction Box Mount + A3819 Junction Box*
 + A3821 Pow Hrns + A3494 3m CAN Hrns + Y1071 Terminator

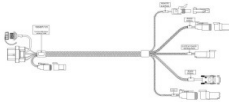
X25 Automatic Guidance - 3rd Party Steer Ready

X25 Auto Guidance - 3rd Party Steer Ready Kit		USD List Price
1005348-01 	KIT, X25 AGI-4 GEN 2 BASE <i>1005348-01 kit contains:</i> AGA4395 <i>Kit, X25 TPA AM</i> 1003561-01 <i>AGI-4</i>	\$ 7,500.00
1003933-01 	KIT, X25/X30 Gen2Lite Universal <i>1003933-01 kit contains:</i> AGA4651 <i>CAN Adaptor Deutsch to Turck</i> AGA4700 <i>HRNS GENERIC AGI-4 ROOF EXTENSION</i> AGA5245 <i>Eyelet Power Adaptor</i>	\$ 750.00
AGA5249 	Kit, ACU-1 Generic Adaptor <i>AGA5249 kit contains:</i> A3601 <i>ACU-1 ASSEMBLY COMPLETE</i> A3626 <i>SYSTEM 150 CONSOLE POWER HARNESS</i> Y004 <i>CABLE TIE 380mm x 4.8mm BLACK</i> Y1073 <i>CAN TERMINATOR MALE TURCK</i> Y1091 <i>CAN TEE F/MALE-F/MALE-MALE</i>	\$ 1,400.00

Note: Select one Steer Ready Kit and suitable Bracket

Steer Ready Kits	Bracket Required
AGA5145 Kit, CIH 10/20/30 SERIES COMB STEER READY	D \$ 1,100.00
AGA5141 Kit, CIH MX / T8000 ENCODER STEER READY	D \$ 550.00
AGA5142 Kit, CIH MX / T8000 TRANSDUCER STEER READY	D \$ 1,100.00
AGA5139 Kit, CIH PUMA / T7000 STEER READY	D \$ 1,100.00
AGA5143 Kit, CIH STX / T9000 ENCODER STEER READY	D \$ 1,100.00
AGA5144 Kit, CIH STX / T9000 FLOW SWITCH STEER READY	D \$ 1,300.00
AGA5138 Kit, JD 6X30/7X30/8X30 NON ILS STEER READY	M \$ 1,100.00
AGA5137 Kit, JD 7X30/ 8X30 ILS STEER READY	M \$ 2,000.00
AGA5135 Kit, JD ARCTIC 9020 / 9030 STEER READY	M \$ 1,300.00
AGA5080 Kit, RAVEN SMARTRAX STEER VALVE (Hirschmann Connectors)	M \$ 1,100.00
AGA5158 KIT INTERFACE TO AUTOFARM HYD VALVE	M \$ 1,100.00

Bracket Kits

Refer to Page: 35-36

GPS Receivers and Options

Refer to Page: 27-28

X25 Automatic Guidance - Integrated Steering Systems

X25 Auto Guidance - Integrated Steering Kit USD List Price

1005348-01 KIT, X25 AGI-4 GEN 2 BASE \$ 7,500.00



1005348-01 kit contains:
 AGA4395 Kit, X25 TPA AM
 1003561-01 AGI-4

Note: Select one Steer Ready Kit and suitable Bracket

Steer Ready Kits Bracket Required

AGA5027	Kit, CIH 8800 STEER READY Note: Requires AGA5071	E	\$	1,500.00
AGA5450	KIT, CLAAS LEX 700 GEN II LITE FOR X25/X30	F	\$	995.00
AGA5054	KIT KRONE NEW CAB SYS 350 VEHICLE	L	\$	2,445.00
AGA5419	KIT JD R SERIES SYSTEM 350 AGI-4 VEHICLE	K	\$	1,995.00
AGA5421	KIT JD R SERIES SYSTEM 350 AGI-3 VEHICLE	K	\$	1,995.00

Unlock code must be purchased from John Deere dealer

John Deere models covered:

6105R, 6115R, 6125R, 6130R, 6140R, 6150R, 6170R, 6190R, 6210R

On ALL 6R models tractor TEC and TEI controller software versions 6.20 or above is required

7200R, 7215R, 7230R, 7260R, 7280R
 7210R, 7230R, 7250R, 7270R, 7290R, 7310R

8235R, 8260R, 8285R, 8310R, 8335R, 8360R, 8310RT, 8335RT, 8360RT
 8245R, 8270R, 8295R, 8320R, 8345R, 8370R, 8320RT, 8345RT, 8370RT

9360R, 9410R, 9460R, 9510R, 9560R, 9460RT, 9510RT, 9560RT

Bracket Kits

Refer to Page: 35-36

GPS Receivers and Options

Refer to Page: 27-28

X25 Automatic Guidance - AGCO Steer Ready

X25 Auto Guidance - AGCO Steer Ready Kits USD List Price

1005348-01 KIT, X25 AGI-4 GEN 2 BASE **\$ 7,500.00**



1005348-01 kit contains:
 AGA4395 *Kit, X25 TPA AM*
 1003561-01 *AGI-4*

Harness Kit Options

1004632-01 KIT X25/X30 AGCO SR GENERIC ECONOMY **\$ 750.00**

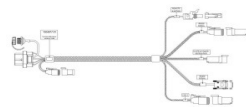

1004632-01 kit contains:
 1001006-01 *AGI-4 to AGCO Amphenol Roof Harness*
 1004642-01 *X25/X30 to AGCO Steer Ready Cab*
 AGA5245 *Eyelet Power Adaptor*

Note: Does Not Suit Fendt

AGA5404 KIT FENDT COM3B X25/X30 AGI4 VEHICLE STD **\$ 650.00**

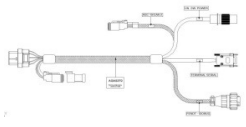

AGA5404 kit contains:
 AGA5370 *Cab Harness, suits Com3B Fendt for X family consoles*
 AGA5329 *Receiver serial crossover harness to suit Fendt / AGI-4*
 AGA5403 *Hardware Accessory Kit to suit Fendt Install*

Note: Suits Fendt

Cab Harness Accessories

AGA5246 AMP STYLE CONVENIENCE PLUG POWER ADAPTER **\$ 75.00**

Note: Connects to power separation connector on Gen2Lite harnesses for alternative source of sys power

AGA5259 COBO STYLE CONVENIENCE PLUG POWER ADAPTER **\$ 75.00**

Note: Connects to power separation connector on Gen2Lite harnesses for alternative source of sys power

AGA5293 ROCKER SWITCH, SWITCHED POWER KIT **\$ 160.00**

Note: Works with AGA5245 Eyelet harness to provide simple rocker switch power for console startup/shutdown

Bracket Kits

Refer to Page: 35-36

GPS Receivers and Options

Refer to Page: 27-28

Optional Harnessing Accessories

AGA5428 AGI-4 EXTERNAL MODEM ADAPTER **\$ 510.00**

Note: Exposes AGI-4 Serial port for external modem connection for receiver

1004094-01 FENDT RTK ANTENNA RELOCATION BRACKET KIT **\$ 200.00**

Note: For high gain antenna only

Note: Relocates AGI-4 RTK antenna to side of roof for Fendt Tractors where receiver is recessed into cab roof



AGA5071 SYSTEM 150 KIT TO X25/X30 ADAPTER WITH ISOBUS SUPPORT **\$ 655.00**

Note: Easy upgrade from existing System 150 harnessing already installed to adapt to X25/X30

AGA4903 AGI-3 TO AGI-4 ADAPTER HARNESS **\$ 400.00**

Note: Easy upgrade from existing AGI-3 roof harness to adapt to AGI-4

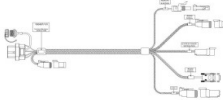
X25 Automatic Guidance - Full Topcon Hydraulic Solutions

X25 Auto Guidance - Full Topcon Hydraulic Kit		USD List Price
1005348-01 	KIT, X25 AGI-4 GEN 2 BASE <i>1005348-01 kit contains:</i> AGA4395 <i>Kit, X25 TPA AM</i> 1003561-01 <i>AGI-4</i>	\$ 7,500.00
1003933-01 	KIT, X25/X30 Gen2Lite Universal <i>1003933-01 kit contains:</i> AGA4651 <i>CAN Adaptor Deutsch to Turck</i> AGA4700 <i>HRNS GENERIC AGI-4 ROOF EXTENSION</i> AGA5245 <i>Eyelet Power Adaptor</i>	\$ 750.00
AGA5249 	Kit, ACU-1 Generic Adaptor <i>AGA5249 kit contains:</i> A3601 <i>ACU-1 ASSEMBLY COMPLETE</i> A3626 <i>SYSTEM 150 CONSOLE POWER HARNESS</i> Y004 <i>CABLE TIE 380mm x 4.8mm BLACK</i> Y1073 <i>CAN TERMINATOR MALE TURCK</i> Y1091 <i>CAN TEE F/MALE-F/MALE-MALE</i>	\$ 1,400.00
AGA5134	Kit, After Market Hydraulic A3223 <i>Hydraulic Block w/15 LT Valve</i> A3671 <i>Wheel Angle Sensor</i> AGA3813 <i>Harness, ACU1 to Hydraulic Block</i> AGA3831 <i>Harness, Isolation Valve Adaptor</i> AGA3950 <i>Harness, ACU1 Power</i> AGM383 <i>Generic WAS Bracket</i>	\$ 5,000.00

Note: Select one Hydraulic Hose Kit and suitable Bracket

Hydraulic Hose Kits

Refer to Page: 37

Bracket Kits

Refer to Page: 35-36

GPS Receivers and Options

Refer to Page: 27-28

X30 Manual Guidance



The X30 is the flagship of Topcon consoles. It has already earned a reputation as a easiest-to-use console on the market today. This premium featured console offers an intuitive user interface with icon-based, user-definable, multi-touch screen. Features such as mini-view drag-and-drop info windows and many others provide positive, precise feedback from your equipment.

The X30 can simultaneously display five different functions on the touchscreen.

Part Number	Description	USD List Price
-------------	-------------	----------------

X30 Manual Guidance

1005381-01	KIT, X30/SGR-1	\$ 6,995.00
-------------------	-----------------------	--------------------



1005381-01 kit contains:

AGA4477	X30 TPA COMP W/SOFTWARE
AGA4265	SGR-1 receiver
1005509-01	Harness X25/X30 to SGR-1
AGA5245	Eyelet Power Adaptor

Options

Power Options:

AGA5259	COBO Power Adaptor	\$ 75.00
AGA5246	AMP Power Adaptor	\$ 75.00
AGA5245	Eyelet Power Adaptor	\$ 75.00
AGA5293	Switched Power Kit	\$ 160.00

Options:

AGA4477	X30 TPA COMP W/SOFTWARE	\$ 5,860.00
AGM357	Bracket, SGR-1 Roof Mounting	\$ 20.00

X30 Automatic Guidance



The X30 combined with AGI-4 receiver/steering controller provides auto guidance that brings state-of-the-art power to your agricultural operations. Featuring simple and easy-to-use Horizon software, the X30 console provides a versatile work platform with features to improve farm management, increase efficiency, enhance machine capabilities, and lower input costs.

This is a complete integrated steering solution, featuring multiple-constellation GNSS satellite reception, state-of-the-art inertial sensors, and full terrain compensation.

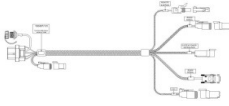
Part Number	Description	USD List Price
X30 Base Kit		
1003325-01	KIT, X30 AGI-4 GEN 2 BASE	\$ 10,500.00
	<i>1003325-01 kit contains:</i>	
	AGA4477 X30 TPA COMP W/SOFTWARE	
	1003561-01 AGI-4	
1003933-01	KIT, X25/X30 Gen2Lite Universal	\$ 750.00
	<i>1003933-01 kit contains:</i>	
	AGA4651 CAN Adaptor Deutsch to Turck	
	AGA4700 HRNS GENERIC AGI-4 ROOF EXTENSION	
	AGA5245 Eyelet Power Adaptor	

GPS Receivers and Options

Refer to Page: **27-28**

Options

1005089-01	Kit VDC and Universal Bracket	\$ 650.00
	<i>1005089-01 kit contains:</i>	
	1003393-01 VDC Controller	
	1004112-01 Harness VDC CAN/Power	
	AGA5486 Kit, Mounting Bracket for VDC Controller	
<i>Power Options:</i>		
AGA5259	COBO Power Adaptor	\$ 75.00
AGA5246	AMP Power Adaptor	\$ 75.00
AGA5245	Eyelet Power Adaptor	\$ 75.00
AGA5293	Switched Power Kit	\$ 160.00
<i>Remote Engage:</i>		
AGA5079	Remote Engage Kit	\$ 160.00

X30 Automatic Guidance AES-25

X30 Auto Guidance AES-25 Kit USD List Price

1003325-01 KIT, X30 AGI-4 GEN 2 BASE \$ 10,500.00



1003325-01 kit contains:
 AGA4477 X30 TPA COMP W/SOFTWARE
 1003561-01 AGI-4

1003933-01 KIT, X25/X30 Gen2Lite Universal \$ 750.00

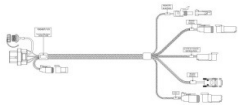

1003933-01 kit contains:
 AGA4651 CAN Adaptor Deutsch to Turck
 AGA4700 HRNS GENERIC AGI-4 ROOF EXTENSION
 AGA5245 Eyelet Power Adaptor

AGA3856 AES-25 Electric Steering Wheel \$ 3,895.00



AGA3856 Kit contains:
 A3494 CAN EXTENSION 3 METRES (10ft)
 A3763 ELEC STEER SYSTEM MODULE
 A3819 ASSY AES-25 PWR STEER JCTN BOX
 A3821 HRNS, ELEC STEER PWR STEER
 AGA3873 ELEC STEER JNCTN BOX MNTG BRKT
 A3825 ELEC STEER WHEEL LOGO CAP
 Y1071 CAN TERMINATOR F/MALE TURCK

Note: Select one Bracket Kit and an Adaptor Kit:

Adaptor Kits

Refer to Page: 29-34

Bracket Kits

Refer to Page: 35-36

GPS Receivers and Options

Refer to Page: 27-28

Options



AGA5296 AES-25 Wheel Angle Sensor Kit \$ 750.00

AGA5296 Kit contains:
 A3671 Wheel Angle Sensor & Brackets + AGA5376 Harness for AES-25 WAS

AGA4124 AES-25 TRANSFER KIT \$ 950.00

AGA4124 Kit contains:
 AGA3873 Junction Box Mount + A3819 Junction Box
 + A3821 Pow Hrns + A3494 3m CAN Hrns + Y1071 Terminator

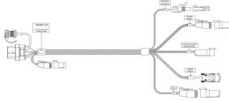
X30 Automatic Guidance - 3rd Party Steer Ready

X30 Auto Guidance - 3rd Party Steer Ready Kit		USD List Price
1003325-01 	KIT, X30 AGI-4 GEN 2 BASE <i>1003325-01 kit contains:</i> AGA4477 X30 TPA COMP W/SOFTWARE 1003561-01 AGI-4	\$ 10,500.00
1003933-01 	KIT, X25/X30 Gen2Lite Universal <i>1003933-01 kit contains:</i> AGA4651 CAN Adaptor Deutsch to Turck AGA4700 HRNS GENERIC AGI-4 ROOF EXTENSION AGA5245 Eyelet Power Adaptor	\$ 750.00
AGA5249 	Kit, ACU-1 Generic Adaptor <i>AGA5249 kit contains:</i> A3601 ACU-1 ASSEMBLY COMPLETE A3626 SYSTEM 150 CONSOLE POWER HARNESS Y004 CABLE TIE 380mm x 4.8mm BLACK Y1073 CAN TERMINATOR MALE TURCK Y1091 CAN TEE F/MALE-F/MALE-MALE	\$ 1,400.00

Note: Select one Steer Ready Kit and suitable Bracket

Steer Ready Kits	Bracket Required
AGA5145 Kit, CIH 10/20/30 SERIES COMB STEER READY	D \$ 1,100.00
AGA5141 Kit, CIH MX / T8000 ENCODER STEER READY	D \$ 550.00
AGA5142 Kit, CIH MX / T8000 TRANSDUCER STEER READY	D \$ 1,100.00
AGA5139 Kit, CIH PUMA / T7000 STEER READY	D \$ 1,100.00
AGA5143 Kit, CIH STX / T9000 ENCODER STEER READY	D \$ 1,100.00
AGA5144 Kit, CIH STX / T9000 FLOW SWITCH STEER READY	D \$ 1,300.00
AGA5138 Kit, JD 6X30/7X30/8X30 NON ILS STEER READY	M \$ 1,100.00
AGA5137 Kit, JD 7X30/ 8X30 ILS STEER READY	M \$ 2,000.00
AGA5135 Kit, JD ARCTIC 9020 / 9030 STEER READY	M \$ 1,300.00
AGA5080 Kit, RAVEN SMARTRAX STEER VALVE (Hirschmann Connectors)	M \$ 1,100.00
AGA5158 KIT INTERFACE TO AUTOFARM HYD VALVE	M \$ 1,100.00

Bracket Kits

Refer to Page: 35-36

GPS Receivers and Options

Refer to Page: 27-28

X30 Automatic Guidance - Integrated Steering Systems

X30 Auto Guidance - Integrated Steering Kit

USD List Price

1003325-01

KIT, X30 AGI-4 GEN 2 BASE

\$ 10,500.00



1003325-01 kit contains:

AGA4477

X30 TPA COMP W/SOFTWARE

1003561-01

AGI-4

Note: Select one Steer Ready Kit and suitable Bracket

Steer Ready Kits

Bracket Required

AGA5027	Kit, CIH 8800 STEER READY Note: Requires AGA5071	E	\$	1,500.00
AGA5450	KIT, CLAAS LEX 700 GEN II LITE FOR X25/X30	F	\$	995.00
AGA5054	KIT KRONE NEW CAB SYS 350 VEHICLE	L	\$	2,445.00
AGA5419	KIT JD R SERIES SYSTEM 350 AGI-4 VEHICLE	K	\$	1,995.00
AGA5421	KIT JD R SERIES SYSTEM 350 AGI-3 VEHICLE	K	\$	1,995.00

Unlock code must be purchased from John Deere dealer

John Deere models covered:

6105R, 6115R, 6125R, 6130R, 6140R, 6150R, 6170R, 6190R, 6210R

On ALL 6R models tractor TEC and TEI controller software versions 6.20 or above is required

7200R, 7215R, 7230R, 7260R, 7280R

7210R, 7230R, 7250R, 7270R, 7290R, 7310R

8235R, 8260R, 8285R, 8310R, 8335R, 8360R, 8310RT, 8335RT, 8360RT

8245R, 8270R, 8295R, 8320R, 8345R, 8370R, 8320RT, 8345RT, 8370RT

9360R, 9410R, 9460R, 9510R, 9560R, 9460RT, 9510RT, 9560RT

Bracket Kits

Refer to Page: 35-36

GPS Receivers and Options

Refer to Page: 27-28

X30 Automatic Guidance - AGCO Steer Ready

X30 Auto Guidance - AGCO Steer Ready Kits

USD List Price

1003325-01 KIT, X30 AGI-4 GEN 2 BASE \$ 10,500.00



1003325-01 kit contains:

AGA4477 X30 TPA COMP W/SOFTWARE
1003561-01 AGI-4

Harness Kit Options

1004632-01 KIT X25/X30 AGCO SR GENERIC ECONOMY Note: Does Not Suit Fendt \$ 750.00

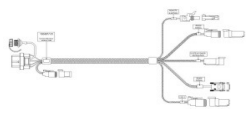

1004632-01 kit contains:

1001006-01 AGI-4 to AGCO Amphenol Roof Harness
1004642-01 X25/X30 to AGCO Steer Ready Cab
AGA5245 Eyelet Power Adaptor

AGA5404 KIT FENDT COM3B SYS 350 AGI4 VEHICLE STD Note: Suits Fendt \$ 650.00

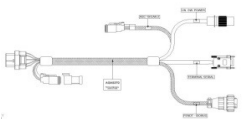

AGA5404 kit contains:

AGA5370 Cab Harness, suits Com3B Fendt for X family consoles
AGA5329 Receiver serial crossover harness to suit Fendt / AGI-4
AGA5403 Hardware Accessory Kit to suit Fendt Install

Cab Harness Accessories

AGA5246 AMP STYLE CONVENIENCE PLUG POWER ADAPTER \$ 75.00

Note: Connects to power separation connector on Gen2Lite harnesses for alternative source of sys power

AGA5259 COBO STYLE CONVENIENCE PLUG POWER ADAPTER \$ 75.00

Note: Connects to power separation connector on Gen2Lite harnesses for alternative source of sys power

AGA5293 ROCKER SWITCH, SWITCHED POWER KIT \$ 160.00

Note: Works with AGA5245 Eyelet harness to provide simple rocker switch power for console startup/shutdown

Bracket Kits

Refer to Page: **35-36**

GPS Receivers and Options

Refer to Page: **27-28**

Optional Harnessing Accessories

AGA5428 AGI-4 EXTERNAL MODEM ADAPTER \$ 510.00

Note: Exposes AGI-4 Serial port for external modem connection for receiver

1004094-01 FENDT RTK ANTENNA RELOCATION BRACKET KIT \$ 200.00

Note: For high gain antenna only

Note: Relocates AGI-4 RTK antenna to side of roof for Fendt Tractors where receiver is recessed into cab roof



AGA5071 SYSTEM 150 KIT TO X25/X30 ADAPTER WITH ISOBUS SUPPORT \$ 655.00

Note: Easy upgrade from existing System 150 harnessing already installed to adapt to X25/X30

AGA4903 AGI-3 TO AGI-4 ADAPTER HARNESS \$ 400.00

Note: Easy upgrade from existing AGI-3 roof harness to adapt to AGI-4

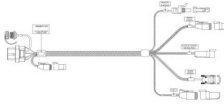
X30 Automatic Guidance - Full Topcon Hydraulic Solutions

X30 Auto Guidance - Full Topcon Hydraulic Kit		USD List Price
1003325-01 	KIT, X30 AGI-4 GEN 2 BASE <i>1003325-01 kit contains:</i> AGA4477 X30 TPA COMP W/SOFTWARE 1003561-01 AGI-4	\$ 10,500.00
1003933-01 	KIT, X25/X30 Gen2Lite Universal <i>1003933-01 kit contains:</i> AGA4651 CAN Adaptor Deutsch to Turck AGA4700 HRNS GENERIC AGI-4 ROOF EXTENSION AGA5245 Eyelet Power Adaptor	\$ 750.00
AGA5249 	Kit, ACU-1 Generic Adaptor <i>AGA5249 kit contains:</i> A3601 ACU-1 ASSEMBLY COMPLETE A3626 SYSTEM 150 CONSOLE POWER HARNESS Y004 CABLE TIE 380mm x 4.8mm BLACK Y1073 CAN TERMINATOR MALE TURCK Y1091 CAN TEE F/MALE-F/MALE-MALE	\$ 1,400.00
AGA5134	Kit, After Market Hydraulic A3223 Hydraulic Block w/15 LT Valve A3671 Wheel Angle Sensor AGA3813 Harness, ACU1 to Hydraulic Block AGA3831 Harness, Isolation Valve Adaptor AGA3950 Harness, ACU1 Power AGM383 Generic WAS Bracket	\$ 5,000.00

Note: Select one Hydraulic Hose Kit and suitable Bracket

Hydraulic Hose Kits

Refer to Page: 37

Bracket Kits

Refer to Page: 35-36

GPS Receivers and Options

Refer to Page: 27-28

AGI-4 UT Steering



Part Number	Description	USD List Price	
AGI-4 BASE KIT			
1003561-01	ASSY,AGI-4 AM, NO MODULES, BOXED	\$	6,250.00
Note: Select one Steer Ready Kit and suitable Bracket			
AGCO VT Options		Bracket Required	
1001006-01	HARNESS,AGI-4 ROOF ADAPTER	A	\$ 375.00
John Deere R Series Direct Interface Kits		Bracket Required	
AGA5422	KIT, JD R SERIES UT AGI-4 VEHICLE	K	\$ 1,750.00

Unlock code must be purchased from John Deere dealer

John Deere models covered:

6105R, 6115R, 6125R, 6130R, 6140R, 6150R, 6170R, 6190R, 6210R

On ALL 6R models tractor TEC and TEI controller software versions 6.20 or above is required

7200R, 7215R, 7230R, 7260R, 7280R

7210R, 7230R, 7250R, 7270R, 7290R, 7310R

8235R, 8260R, 8285R, 8310R, 8335R, 8360R, 8310RT, 8335RT, 8360RT

8245R, 8270R, 8295R, 8320R, 8345R, 8370R, 8320RT, 8345RT, 8370RT

9360R, 9410R, 9460R, 9510R, 9560R, 9460RT, 9510RT, 9560RT

Bracket Kits

Refer to Page: 35-36

GPS Receivers and Options

Refer to Page: 27-28

GPS Receivers and Options



Topcon offers both mobile and stationary base stations, plus a 35-Watt radio is also available for extra range. New to the family is the Topcon HiPer V GNSS mobile base station that is compatible with Topcon receivers from field crop autosteering and machine control to water conservation and landforming. HiPer V is a one-piece, cable-free unit that is rugged and compact.

Part Number	Description	USD List Price
Base Stations		
Net G3A Reference Station		
1011	Kit, NET-G3A Reference Station	\$ 14,000.00
Mobile Base		
1003316-01	KIT, HIPER V AG BASE 915+	\$ 8,950.00
1003317-01	KIT, GR5 AG BASE Kit 915+	\$ 11,950.00
1003318-02	Kit, AG,HiPerV BASE DUHF2 400-430	\$ 8,950.00
1003318-03	Kit, AG,HiPerV BASE DUHF2 430-450	\$ 8,950.00
1003318-01	Kit, AG,HiPerV BASE DUHF2 450-470	\$ 8,950.00
Permanent Base		
1004362-01	Kit, AG Base, MR-1 Permanent, UHF	\$ 8,300.00
1004362-02	Kit, AG Base, MR-1 Permanent, FH915	\$ 8,300.00
Base Station Radio Antenna Required With Permanent Base		
1004557-01	AG Base Station UHF Antenna Kit 406-430	\$ 650.00
1004557-02	AG Base Station UHF Antenna Kit 430-450	\$ 650.00
1004557-03	AG Base Station UHF Antenna Kit 450-470	\$ 650.00
1004558-01	AG Base Station FH915 Antenna kit	\$ 650.00
Radio Upgrade Options		
1004559-01	Kit, AG Base, Radio Upgrade, SRL-35	\$ 2,875.00
Note: When Radio Upgrade Option is used as a repeater, then Radio Antenna Kit is required		
Accessories		
Tripods		
320628121	TP-210T/PS, Aluminum Tripod	\$ 115.00
1004396-01	Topcon Fiberglass Tripod w/ Dual Clamp	\$ 130.00
59010	TP-10 WOOD EXT LEG	\$ 295.00

GPS Receivers and Options continued on next page

GPS Receivers and Options continued



The AGI-4 receiver/steering controller offers GNSS multi-constellation satellite reception for unmatched accuracy. Standard with WAAS/EGNOS; easily upgradeable to 2cm accuracy with RTK radio options. All-in-one, modular design incorporates antenna, receiver and steering controller in a single component, for unmatched upgradeability.

The SGR-1 is a compact, rugged receiver providing simultaneous processing of GPS and GLONASS signals with 32-channel high speed, universal tracking.

Part Number	Description	USD List Price	
Rovers			
AGI-4			
1003561-01	ASSY,AGI-4 AM, NO MODULES, BOXED	\$	6,250.00
SGR-1			
AGA4265	SGR-1 Receiver	\$	1,080.00
AGA4266	SGR-1 Receiver Kit to suit GX-45	\$	1,400.00
AGA4267	SGR-1 Receiver Kit to suit X20	\$	1,400.00
AGA4749	SGR-1 Receiver Kit to suit X30 (only works with AGA5072 harness)	\$	1,400.00
Rover Upgrade Options			
AGI-4 GPS Upgrade Options			
27-100710-02	AGI-4 OmniStar XP/HP/G2 upgrade option	\$	2,000.00
1002411-03	AGI-4 RTK UHF Radio + GSM/3G/HSPA (RTK, IMU & Antenna Kit)	\$	5,500.00
1002411-04	AGI-4 RTK FH915 Radio + GSM/3G/HSPA Module (RTK, IMU & Antenna Kit)	\$	5,500.00
1002411-07	AGI-4 RTK FH915 CDMA UPGD (RTK, IMU & Antenna Kit)	\$	5,500.00
1002411-06	AGI-4 RTK External Radio Option (IMU + RTK Unlock Code)	\$	3,995.00
AGA5428	Harness, AGI-4 Modem Adaptor	\$	510.00
01-104701-01	AGI-4 boxed with AGI-3 to AGI-4 adaptor	\$	6,500.00
AGI-3 GPS Upgrade Options			
AGA3703	AGI-3 OmniStar HP/XP upgrade option for AGI-3	\$	2,000.00
AGA3571	AGI-3 RTK - UHF DIG MODEM W/US GSM	\$	6,000.00
AGA3928	AGI-3 RTK - W/FH 915 US GSM	\$	6,000.00
AGA4608	RTK Module without Radio	\$	3,995.00
AGA4903	Harness, Adaptor AGI-3 to AGI-4	\$	400.00
Antenna Options			
30-030014-01	Antenna, Whip 915	\$	125.00
9900-1037	Magnetic Mount, Whip Antenna	\$	150.00
1004094-01	Kit Fendt COM 3 High Gain UHF Antenna Mount	\$	200.00
	<i>Note: For high gain antenna only</i>		

AES-25 Adaptor Kits

Row Crop Tractors

Part Number	Models	USD List Price
AGCO Row Crop Tractors		
AGA3764	RT100A, RT120A, RT140A, RT155A	\$ 400.00
AGA4039	DT180A, DT200A, DT220A, DT240A DT205B, DT225B, DT250B, DT275B	\$ 470.00
CASE IH Row Crop Tractors		
AGA3827	MX Magnum 180, 200, 210, 215, 220, 225, 230, 240, 245, 250, 255, 270, 275, 280, 285, 305, 310, 335	\$ 420.00
AGA3834	Magnum 7110, 7120, 7130, 7140, 7150 7210, 7220, 7230, 7240, 7250 8910, 8920, 8930, 8940, 8950	\$ 700.00
AGA4181	MXM 120, 130, 140, 155, 175, 190	\$ 290.00
AGA4122	CVX 135, 145, 155, 175, 195, 1135, 1145, 1155, 1170, 1190, 1195	\$ 420.00
AGA4035	Puma 165, 180, 195, 210	\$ 480.00
AGA4058	MX Maxxum 100, 110, 120, 135, 150, 170	\$ 865.00
Challenger Row Crop Tractors		
AGA3764	525B, 535B, 545B, 555B, 565B MT635B, MT645B, MT655B, MT665B, MT685B	\$ 400.00
AGA4039	MT645C, MT655C, MT665C, MT675C MT645D, MT655D, MT665D, MT675D, MT685D	\$ 470.00
CLAAS Row Crop Tractors		
AGA4064	Axion 810, 820, 830, 840, 850 Arion 510, 520, 530, 540 Arion 610, 620, 630, 640 Ares 547, 557 Axos 310, 320, 330, 340	\$ 400.00
Deutz Fahr Row Crop Tractors		
AGA4607	K410, K420, K430, K610 M410, M420, M600, M615, M620, M625, M640, M650 TTV 610, 620, 630 L710, L720 X710, X720	\$ 635.00
Fendt Row Crop Tractors		
AGA4025	711, 712, 714, 716, 718 815, 817, 818, 820 922, 924, 926, 927, 930, 936	\$ 470.00
Fiat Row Crop Tractors		
AGA4037	G170, G190, G210, G240	\$ 635.00

AES-25 Adaptor Kits

JCB Row Crop Tractors			
AGA4109	2155, 2170, 3190, 3200, 3220, 3230, 8250	\$	485.00
John Deere Row Crop Tractors			
AGA3765	4230, 4430, 4630 4040, 4240, 4440, 4640 4050, 4250, 4450, 4650, 4850 4055, 4255, 4455, 4555, 4755, 4955 4560, 4760, 4960	\$	620.00
AGA3766	6100, 6200, 6300, 6400, 6600, 6800 6110, 6210, 6310, 6410, 6610, 6810, 6910, 6910S 6120, 6220, 6320, 6420, 6520, 6620, 6820, 6920, 6920S 7200, 7300, 7400, 7500, 7600, 7700, 7800 7210, 7310, 7410, 7510, 7610, 7710, 7810 7120, 7220, 7320, 7420 SE Spec 7130, 7230, 7330, 7430 SE SE Spec 6130, 6230, 6330, 6430 SE	\$	600.00
AGA3828	Premium Spec 6230, 6330, 6430, 6530, 6630, 6830, 6930, 7530, 7630, 7830, 7930	\$	420.00
AGA3975	5225, 5325, 5425, 5525	\$	640.00
AGA3955	7720, 7820, 7920 Lg. Frame 7730, 7830, 7930 Lg. Frame 8100, 8200, 8300, 8400 8110, 8210, 8310, 8410 8120, 8220, 8320, 8420, 8520 8130, 8230, 8330, 8430, 8530	\$	600.00
Massey Ferguson Row Crop Tractors			
AGA4111	630, 640, 650, 660, 680, 6350, 6360 7140, 7150, 7170, 7180	\$	515.00
AGA4110	7350, 7370, 7390, 7415	\$	475.00
AGA4114	290, 292, 297, 298, 299, 596	\$	570.00
AGA3764	6465, 6475, 6480, 6485, 6490, 6495, 6497, 6499 7465, 7475, 7480, 7485, 7490, 7495 8220, 8240, 8245, 8250, 8260, 8270, 8280 8450, 8460, 8470, 8480	\$	400.00
AGA4039	8650, 8660, 8670, 8680, 8690	\$	470.00
McCormick Row Crop Tractors			
AGA5429	MC, MTX, XTX, TTX, ZTX	\$	600.00
New Holland			
AGA4037	8670, 8770, 8870, 8970 8670A, 8770A, 8870A, 8970A	\$	680.00
AGA4181	TM 120, 130, 135, 140, 150, 155 165, 175, 190	\$	290.00
AGA4083	TG 210, 215, 230, 245, 255, 275, 285, 305, T8010, T8020, T8030, T8040	\$	510.00
AGA4035	T6020, T6030, T6040, T6050, T6060, T6070, T6080, T7030, T7040, T7050, T7060	\$	480.00

AES-25 Adaptor Kits

Valtra Row Crop Tractors

AGA4038	T121, T131, T151e, T161, 171, 191 N82, N92, N101, N111e, N121, N141	\$ 440.00
AGA4039	S232, S262, S292, S322, S352	\$ 470.00
AGA4238	BM85, BM100, BH145, BH165, BH180, BH185i BT150, BT170, BT190, BT210	\$ 570.00
AGA4145	A75, A85, A95	\$ 515.00

Tracked Tractors

Caterpillar Tracked Tractors

AGA4138	65C, 70C, 75C, 85C 65D, 75D, 85D 65E, 75E, 85E, 95E	\$ 690.00
AGA4037	35, 45, 55 CH	\$ 635.00

Challenger Tracked Tractors

AGA4160	MT755A, MT765A, MT855A, MT865A MT755B, MT765B, MT855B, MT865B	\$ 830.00
AGA3959	MT755C, MT765C, MT835C, MT845C, MT855C, MT865C, MT875C	\$ 830.00

John Deere Tracked Tractors

AGA3955	8200T, 8300T, 8400T 8210T, 8310T, 8410T 8320T, 8420T, 8520T 8330T, 8430T, 8530T 9300T, 9400T 9320T, 9420T, 9520T, 9620T 9330T, 9430T, 9530T, 9630T	\$ 600.00
---------	--	-----------

4WD Tractors

Buhler 4WD Tractors

AGA4037	Versatile 305, 340, 375, 400 Versatile HHT 435, 485, 535 Versatile HHT 575 2290, 2335, 2360, 2375, 2425	\$ 635.00
---------	--	-----------

Case IH 4WD Tractors

AGA3827	STX 275, 325, 375, 425, 440, 450, 500, 530 STX Quadtrack 375, 425, 450, 500	\$ 420.00
AGA4138	9150, 9170, 9180, 9210, 9230, 9240, 9250, 9260, 9270, 9280 9310, 9330, 9350, 9370, 9380, 9390 9370 Quadtrack	\$ 690.00

Challenger 4WD Tractors

AGA3959	MT945C, MT955C, MT965C, MT975C	\$ 830.00
AGA4160	MT945B, MT955B, MT965B	\$ 830.00

CLAAS 4WD Tractors

AGA4037	Xerion	\$ 635.00
---------	--------	-----------

AES-25 Adaptor Kits

Ford New Holland/Versatile 4WD Tractors

AGA4138	846, 876, 936, 946, 976	\$	690.00
AGA4037	9184, 9280, 9282, 9384, 9480, 9482, 9484, 9680, 9682, 9684, 9880, 9882, 9884	\$	635.00

John Deere 4WD Tractors

AGA3765	8430, 8630 8440, 8640 8450, 8650, 8850 8560, 8760, 8960 8570, 8770, 8870, 8970	\$	620.00
---------	--	----	--------

John Deere 4WD Tractors continued

AGA3955	9100, 9200, 9300, 9400 9220 9320, 9420, 9520 9620 9230, 9330, 9430, 9530, 9630	\$	600.00
---------	--	----	--------

New Holland 4WD Tractors

AGA3827	TJ275, TJ325, TJ440, TJ375, TJ425, TJ450, TJ500, TJ530 T9020, T9030, T9040, T9050, T9060	\$	420.00
---------	---	----	--------

Steiger 4WD Tractors

AGA4138	Bearcat, Cougar, Panther, Tiger	\$	690.00
---------	---------------------------------	----	--------

Combines

Case IH Combines

AGA3961	1644, 1688, 2144, 2166, 2188, 2344, 2366, 2388	\$	470.00
AGA3974	6088, 7088, 7010, 8010 7020, 8120, 9120	\$	670.00

Challenger Combines

AGA4698	660B, 670B, 680B	\$	880.00
---------	------------------	----	--------

Claas Combines

AGA4044	Lexion 510, 520, 530, 540, 540C, 550, 560, 570, 570C, 580, 600, 670, 730, 740, Lexion 750, 760, 770 Montana 530, 550, 560, 570 Tucano 320, 330, 340, 430, 440, 450	\$	680.00
---------	---	----	--------

Fendt Combines

AGA4698	8370, 8400, 9470X	\$	880.00
---------	-------------------	----	--------

Gleaner Combines

AGA3977	R52 , R62, R72	\$	990.00
AGA3982	R65, R75	\$	360.00
AGA4698	R66, R76, A86, S67, S77	\$	880.00

John Deere Combines

AGA3966	9400, 9500, 9600, CTS 9410, 9510, 9610, CTS II 9450,9550, 9650, 9650CTS, 9650STS, 9750STS 9560STS, 9660STS, 9760STS, 9860STS 9570STS, 9670STS, 9770STS, 9870STS, 9780STS, 9880STS 1470, 1570, S560, S660i T550, T560, T660, T670 W540, W540c, W550, W650, W660, C670	\$	800.00
---------	---	----	--------

AES-25 Adaptor Kits

Massey Ferguson Combines

AGA4118	32, 34, 38	\$	1,200.00
AGA3982	9690, 9790, 9890	\$	360.00
AGA4698	9695, 9795, 9895 7280, 7282 9280	\$	880.00

New Holland Combines

AGA3974	CR 940, 960, 970, 980 CR 9040, 9060, 9070, 9080, 9090 CX8080, CX8090	\$	670.00
AGA3960	TR 87, 88, 97, 98, 99	\$	690.00
AGA4063	TX99	\$	320.00

Valtra Combines

AGA4126	Valtra BC4500	\$	590.00
---------	---------------	----	--------

Windrowers

Case IH Windrowers

AGA3974	WDX 1202, 1902, 1702, 2302	\$	670.00
---------	----------------------------	----	--------

Challenger Windrowers

AGA3979	SP115C, SP185C	\$	525.00
---------	----------------	----	--------

Hesston AGCO Windrowers

AGA3979	9435, 9635	\$	525.00
---------	------------	----	--------

MacDon Windrowers

AGA3967	9300, 9350, 9352c, 9352i	\$	495.00
---------	--------------------------	----	--------

Massey Ferguson Windrowers

AGA3979	9435, 9635	\$	525.00
---------	------------	----	--------

Floaters

AgChem Terragator Floaters

AGA4138	1603, 1803, 1903	\$	690.00
AGA4037	8203, 9203, 9205	\$	635.00

Case IH Floaters



AGA4083	3020, 3520	\$	510.00
---------	------------	----	--------

AES-25 Adaptor Kits

Sprayers

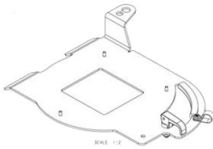

AgChem Rogator Sprayers			
AGA4037	1254, 1264, 1274, 1274C, 1286, 1286C	\$	635.00
Case IH Sprayers			
AGA4083	SPX 3330, 4420	\$	510.00
Jacto Sprayers			
AGA4141	Uniport 3000	\$	1,020.00
John Deere Sprayers			
AGA3766	4700, 4710,	\$	600.00
AGA3955	4720, 4730, 4830, 4920, 4930	\$	600.00
Miller Sprayers			
AGA3966	4215, 4240, 4275, 4315, 4365 N2XP	\$	800.00

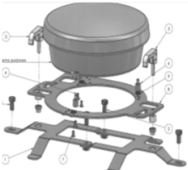
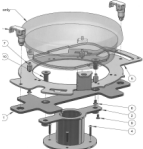
Roof Mount Bracket Kits

Part Number	Models	USD List Price
AGCO Vehicles		
A 1001005-01	KIT, BRACKET RECEIVER AGI-4, AGCO STEER READY <i>Row Crop Tractors Supported:</i> Challenger MT 5xxB,C,D,E Challenger MT 6xxB,C,D,E AGCO RT xxxA, DT xxxA, DT xxxB Valtra S, T, N, BH, BT Massey Ferguson 64xx, 66xx Massey Ferguson 71xx, 74xx, 76xx Massey Ferguson 82xx, 84xx, 86xx <i>Tracked Tractors Supported:</i> Challenger MT 7xxC, 7xxD, 7xxE, 8xxB, 8xxC, 8xxE <i>Articulated Tractors Supported:</i> Challenger MT 9xxC, MT9xxE <i>Harvestors Supported:</i> AGCO Gleaner Transverse AGCO Gleaner Axial Massey Ferguson Challenger 6xxB Laverda ML800	\$ 175.00
		
B AGA4609	KIT, BRACKET RECEIVER AGI-4 / AGI-3, AGCO WINDROWERS <i>Massey Ferguson Windrower Models Supported:</i> Massey Ferguson Windrower MF9435, MF9635 Wide Cab Note: For the AGCO WR series Steer Ready Models DO NOT USE AGA4609 Instead please source AGCO PN: 700958137 from your local AGCO Dealer and 1001005-01	\$ 800.00
		
C AGA3788	KIT, BRACKET RECEIVER AGI-3 ONLY, AGCO Steer Ready	\$ 175.00
CASE NEW HOLLAND Vehicles		
D A3734	KIT, BRACKET RECEIVER AGI-4 / AGI-3, CASE NEW HOLLAND Note: Receiver Not Included	\$ 175.00
		
E AGA4511	KIT, BRACKET RECEIVER AGI-4 / AGI-3, CASE 8800 SUGARCANE HARVESTER Note: Receiver Not Included	\$ 500.00
		
CLAAS LEXION Vehicles		
F AGA4905	KIT, BRACKET RECEIVER AGI-4 / AGI-3, CLAAS LEXION Note: Receiver Not Included	\$ 550.00
		

Roof Mount Bracket Kits

Fendt Vehicles

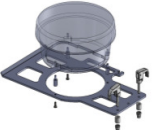
G AGA5373	KIT, BRACKET RECEIVER AGI-4, FENDT INTERNAL	\$ 80.00
	<i>Fendt Models Supported:</i> Fendt COM3B 7xx / 8xx / 9xx Internal	
	Note: Utilizes Varioguide mounting location, if equipped, recessed in roof of tractor, suits AGI-4 ONLY	
H AGA5194	KIT, BRACKET RECEIVER AGI-4 / AGI-3, FENDT EXTERNAL	\$ 1,120.00
	<i>Fendt Models Supported:</i> Fendt COM3/COM3B 9xx External	
	Note: Suits Fendt Models that do not have roof bracket or recessed accomodations for GPS Receiver Note: Kit includes the AGA3644 Universal Bracket Kit, plus custom "Fendt-specific" brackets to mount to factory equipped beacon lights.	
I AGA4199	KIT, BRACKET RECEIVER AGI-3 ONLY, Fendt COM3 7xx / 8xx External	\$ 330.00
	Note: Receiver Not Included	

John Deere Vehicles

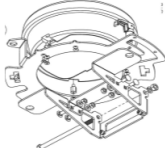
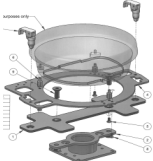
J A3645	KIT, BRACKET RECEIVER AGI-4 / AGI-3, JOHN DEERE STARFIRE	\$ 275.00
	Note: Receiver Not Included	
K AGA5338	KIT, BRACKET RECEIVER AGI-4 / AGI-3, JOHN DEERE R-SERIES	\$ 495.00
	Note: Receiver Not Included	

Krone Vehicles

L AGA5028	KIT AGI-3/4 ROOF MOUNT KRONE NEW CAB	\$ 1,070.00
------------------	---	--------------------

Universal Roof Mount Bracket Kit

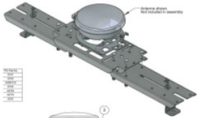
M AGA3644	KIT, BRACKET RECEIVER AGI-4 / AGI-3, UNIVERSAL	\$ 450.00
	Topcon Universal GPS Roof Bracket Suits Various Models	
	Note: Kit includes the AGB1315, aftermarket dual swell latch ring plate for AGI-4 / AGI-3 Note: Receiver Not Included	

Hydraulic Hose Kits

Part Number Description

KIT BOMs are available for each kit upon request

A3513	A900 SERIES FENDT VARIO
A2450	CASE 21xx-23xx COMBINE HARVESTER
A2790	CASE 7100 FWA TRACTOR OPTION 2
A2471	CASE 7100, 7200 & 8900 FWA TRACTOR
A2449	CASE AFX 8010 COMBINE HARVESTER
A3541	CASE CVX CHECK VALVE HOSE
A2551	CASE CVX FRONT WHEEL ASSIST TRACTOR
A2469	CASE MX110-170 FWA TRACTOR
A2473	CASE MX210-285 NO STC OR HYD SUSPEN
A2468	CASE MX210-285 WITH STC FWA TRACTOR
A3486	CASE MX210-285 WITH STC REAR MOUNT
A3518	CASE PUMA 165-210
A3276	CASE STX 280-530 & NH T9000 STEER READY TRACTOR
A2478	CASE STX & NH TJ LGE FRAME 375-500 TRACTOR
A2479	CASE STX & NH TJ SML FRAME 275-325TRACTOR
A2577	CATAPILLAR LEXION 480 COMBINE
A2571	CATERPILLAR CHALLENGER COMBINE
A2675	DEUTZ AGTRON 165 TRACTOR
A2472	FENDT 700 SERIES FWA TRACTOR
A2474	FENDT 900 SERIES FWA TRACTOR
A2488	JD 6000 FRONT WHEEL ASSIST
A2489	JD 7xx0 FRONT WHEEL ASSIST
A2485	JD 8000 FRONT WHEEL ASSIST
A2466	JD 9000 4WD TRACTOR
A2463	JD 9X00 COMBINE HARVESTER
A2446	JD 9X50 & 9X60 COMBINE HARVESTER
A2702	MF8400 SERIES TRACTOR
A2088	MILLER 2275 SELF PROPELLED SPRAYER
A3542	MX CHECK VALVE HOSE FITTING
A2476	MXM 110-155 FWA
A2448	NH CR 9X0 COMBINE HARVESTER
A2467	NH8X70 GENISIS FWA TRACTOR
A2475	NH9682 4WD TRACTOR
A2447	NH-TR 8X, 9X COMBINE HARVESTER
A2156	ROGATOR 1254 SELF PROPELLED SPRAYER
A2424	ROGATOR 1264, 1274 SERIES SP SPRAYER
A3476	ROGATOR 1286C
A2470	STEIGER 9X00 SERIES LGE FRAME TRACTOR
A2480	STEIGER 9X00 SERIES SML FRAME TRACTOR
A3391	OPEN CENTRE HYDRAULIC FITTINGS KIT (NO HOSES)
A3392	CLOSED CENTRE HYDRAULIC FITTINGS KIT (NO HOSES)

X30/X25/GX-45 ASC-10 Sprayer Kits



ASC-10 Kits and Adaptor Kits are to be ordered separately from the list below

Part Number	Description	USD List Price
ASC-10 Base Kits		
AGA4694	Kit ASC-10 Base Spray ECU Kit suit X30 X25 & GX-45 <i>AGA4694 kit contains:</i> A3455 ASC-10 CANBUS ECU COMPLETE AGA4281 HRNS, DEUTSCH TO COBO PWR AGA4282 HRNS, DEUTSCH TO EYELETS PWR AGA4468 HRNS, DEUTSCH DT SERIES 2PIN 5M EXT MALE-F/MALE AGA4598 HRNS ASC-10 CAN ADAPTOR WITH TERMINATOR AGA4635 HRNS, ASC10 CAN EXTENSION 5M WITH DEUTSCH CONNECTORS AGA4651 CAN Adaptor Deutsch to Turck	\$ 1,500.00
Sprayer Specific Solution		
AGA4184	ROGATOR 1286C / 1386C SS SERIES Inside Cab	\$ 700.00
AGA3909	ROGATOR 1254 / 1264 / 1274 / 1274C	\$ 700.00
AGA3913	SPRA COUPE 7XXX Prior to 7650	\$ 700.00
AGA3915	MILLER NITRO 4XXX	\$ 700.00
AGA5260	MILLER NITRO 5XXX	\$ 800.00
Sprayer Adaptor Kits		
AGA3916	RAVEN 440, 460	\$ 500.00
AGA4732	RAVEN SMART BOOM	\$ 700.00
AGA4691	TEEJET 844 / 854	\$ 500.00
AGA4061	MK-5 to ASC-10, suits A862 Harness	\$ 700.00
AGA4622	ASC-10 Sprayer Kit 10 SECTION suit ARAG 3 Wire Valves	\$ 1,100.00
AGA4623	ASC-10 Sprayer Kit 10 SECTION suit TEEJET 3 Wire Valves	\$ 1,100.00
AGA4624	ASC-10 Sprayer Kit 10 SECTION suit ARAG 2 Wire Valves	\$ 1,900.00
AGA4625	ASC-10 Sprayer Kit 5 SECTION suit ARAG 2 Wire Valves	\$ 1,600.00
AGA4626	ASC-10 Sprayer Kit 10 SECTION suit GENERIC 2 Wire Valves	\$ 1,900.00
AGA4627	ASC-10 Sprayer Kit 5 SECTION suit GENERIC 2 Wire Valves	\$ 1,600.00
A3489	ASC-10 Drive Sense Harness	\$ 500.00
AGA4671	Harness, Rate Control Spra Coup 7660 and Later	\$ 1,085.00
Optional - Pressure Readout		
AGA4543	Sensor 10 Bar Pressure 0-5V W/DEUTSCH 3 Pin Plug	\$ 548.00
A870	Control Box for 2 Wire Valves	\$ 800.00
For Flow Meters, Dump Valves, Speed Sensors, Magnets and Extension Harnesses, please refer to Spare Parts Book		

Spreader Control for X25/X30



X30 Spreader Control from Topcon Precision Agriculture is a full-featured controller with Variable Rate Control and mapping capabilities.

Functions of spreader kits are limited to equipment on spreader.

X25/X30 Console is NOT included

Part Number	Description	USD List Price
Spreader Control Kits		
1003763-01	Kit, Universal Single Belt ASC-10 Spreader	\$ 1,500.00
AGA5163	HARNESS, NEW LEADER BELT 2	TBD
AGA5162	HARNESS, NEW LEADER SINGLE BELT & SPINNER	TBD
AGA5485	HRNS ASC10 NEW LEADER RELAY ADAPTOR	TBD

ISOBUS



The ISOBUS extension kit is a solution that works with the current Topcon terminal harness to connect ISOBUS implements to a tractor that has no ISOBUS network installed.

Part Number	Description	USD List Price	
ISOBUS			
NOTE: UT / X25 / X30			
AGA4982	KIT, ROW CROP TRACTOR ISOBUS EXTENSION	\$	2,000.00
AGA5179	KIT, ARTICULATED TRACTOR ISOBUS EXTENSION	\$	2,100.00
AGA5377	HRNS X30 ISO ADAPTOR SUIT AGA5072 and/or AGA4700	\$	95.00

X30/UT Seeder Interface Kit

Part Number	Description	USD List Price
ISOBUS suit Seeder		

The X30/UT Seeder Interface Kit allows existing X20 Seeder Kits using an MDECU to be connected to the X30 via the IB-1 ISOBridge Interface.

NOTE: MINI ECU is not supported

The AGA5291 Kit also allows the IB-1 to display on ISO UT terminals.

NOTE: Limited to MDECU with 4 products in UT mode

MDECU REQUIRES MD36 FIRMWARE

AGA5291	KIT IB-1 ISOBUS SEEDER ECU FOR AGA5072 X30 ISOBUS PWR/COMMS or UT	\$ 2,600.00
----------------	--	--------------------

AGA5291 kit contains:

AGA4634 ISO BRIDGE ECU

AGA4885 HRNS ADAPTOR ISO BRIDGE ECU

AGK159 CAN TERM ISO11783 BIAS CIRCUIT

AGA4678 HRNS ACTIVE ISO11783 TERMINATOR

AGA5251 HRNS ECU ISOBUS EXTENSION

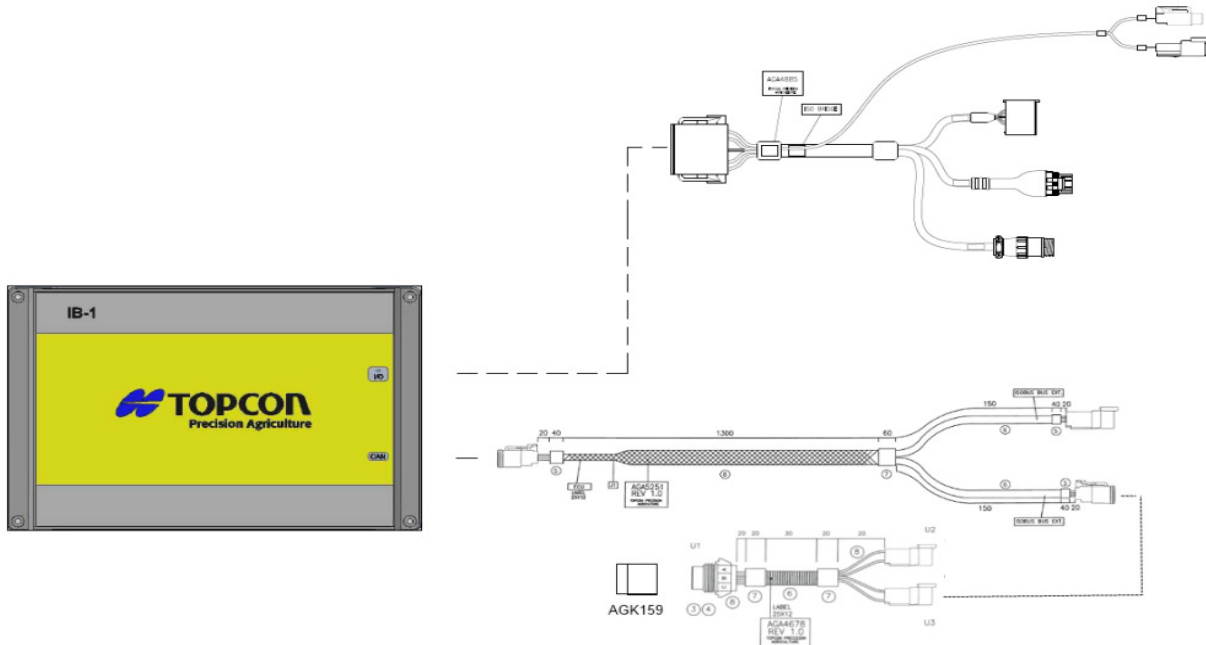

Seeding Control Kits for System 200

Refer to Page: 55

Ag Cam for X30



The X30 Ag Cam System from Topcon is a leader in providing high quality images. View inputs from up to four vehicle mounted video cameras on the same X30 console used for all other precision agriculture functions. Providing high-quality images in a variety of lighting conditions, the X30 Ag Cam gives the operator improved machine control, better safety, and monitoring. The X30 Ag Cam uses a unique camera engineered to reliably withstand harsh environments. Featuring a completely waterproof housing, hi-resolution color and infrared processing, the X30 Ag Cam can be used in a variety of farming applications.

Part Numbers Description

USD List Price

AgCam Kits

Part Numbers	Description	USD List Price
1004683-01	KIT AGCAM 1 CAM W ADAPTER AND CODE 20FT	\$ 1,250.00
	<i>1004683-01 Kit contains:</i>	
1004051-01	PSWD-CG,X30, Camera Code	
1004680-01	ADAPTER AGCAM USB X30 2CAM	
1004681-01	CAMERA AGCAM PAL 92 DEGREES	
A3453	CBL, AGCAM 20FT POWER/VIDEO EXT	
AGA5107	MNL X30 CAMERA MONITOR OPERATOR	
1004682-01	KIT AGCAM 2 CAMS W ADAPTER AND CODE 20FT	\$ 1,700.00
	<i>1004682-01 Kit contains:</i>	
1004051-01	PSWD-CG,X30, Camera Code	
1004680-01	ADAPTER AGCAM USB X30 2CAM	
1004681-01	CAMERA AGCAM PAL 92 DEGREES (2)	
A3453	CBL, AGCAM 20FT POWER/VIDEO EXT (2)	
AGA5107	MNL X30 CAMERA MONITOR OPERATOR	

Options

1004681-01	CAMERA AGCAM PAL 92 DEGREES	\$ 500.00
A3454	AGCAM 60ft EXTENSION HARNESS	\$ 130.00
1004051-01	PSWD-CG,X30, Camera Code	\$ 500.00
	Unlock code required if hardware is purchased separately	

CropSpec for X30/X25

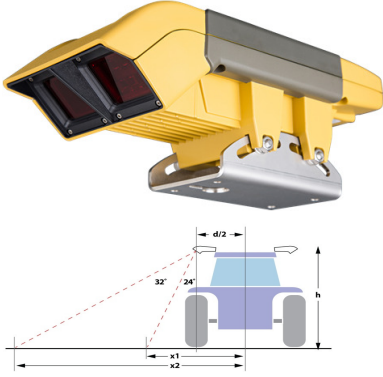

Topcon CropSpec Crop Canopy Sensors were co-developed with Yara, a world leading manufacturer of fertilizers. CropSpec sensors, mounted on the vehicle roof deliver data day and night to the display. Crop N readings can be mapped every time a vehicle travels the field, providing invaluable crop data. Alternatively, utilize display XLinks, or application functionalities so the sensors are able to not only read the N requirements but also provide variable rate application, all in the one field pass.

Note: Advanced feature unlock is required for X25 console

Part Number	Description	USD List Price
-------------	-------------	----------------

X30 CropSpec Kits

1004326-01	KIT, TWO SENSOR CROPSPEC FOR X30/X25	\$ 19,500.00
	<i>1004326-01 Kit contains:</i>	
	<i>319000101 CROPSPEC SENSOR (2)</i>	
	<i>AGA3861 CROPSPEC QUICK MOUNT ADAPT</i>	
	<i>AGA4678 HRNS ACTIVE ISO11783 TERMINATOR</i>	
	<i>AGA5356 HRNS X30 TO 2 CROP SPEC SNSRS</i>	
	<i>AGK159 CAN TERM ISO11783 BIAS CIRCUIT</i>	
1004327-01	KIT, SGL SENSOR CROPSPEC FOR X30/X25	\$ 11,000.00
	<i>1004327-01 Kit contains:</i>	
	<i>319000101 CROPSPEC SENSOR (1)</i>	
	<i>AGA3861 CROPSPEC QUICK MOUNT ADAPT</i>	
	<i>AGA4678 HRNS ACTIVE ISO11783 TERMINATOR</i>	
	<i>AGA5356 HRNS X30 TO 2 CROP SPEC SNSRS</i>	
	<i>AGK159 CAN TERM ISO11783 BIAS CIRCUIT</i>	

X30, X25 and GX-45 Unlock Codes

Part Number	Description	USD List Price
-------------	-------------	----------------

X30 Unlock Codes

The X30 unlock codes provide additional features to be utilized on the X30

AGA5283	AgJunction	\$	1,000.00
AGA5285	Xlinks	\$	1,000.00
1001157-01	Controlled Traffic	\$	2,000.00
1004051-01	AG CAM	\$	500.00
1004052-01	Water Management Code	\$	2,000.00
	Variable Rate Control		TBA

X25 Unlock Codes

The X25 unlock codes provide additional features to be utilized on the X25

1005476-01	Unlock Code X25 Advanced Features	\$	2,000.00
AGA5285	Xlinks	\$	1,000.00
1001157-01	Controlled Traffic	\$	2,000.00

GX-45 Unlock Codes

The GX45 unlock codes provide additional features to be utilized on the GX45

AGA5287	Controlled Traffic	\$	1,000.00
AGA5288	Bravo 300S Xlink	\$	1,000.00
AGA5289	Variable Rate Control	\$	500.00

10 Day demo codes available upon request

SGIS Software and Subscriptions

Part Number	Description	USD List Price
SGIS Farm		
AGA4985	SGISfarm Software and Subscription	\$ 1,500.00
AGA4986	SGISfarm Renewal Subscription	\$ 275.00
AGA4987	SGISfarm Renewal Subscription, no maintenance	POA
AGA4988	SGISfarm Replacement	POA
SGIS Pro		
599926	SGISpro Software and Subscription	\$ 3,650.00
599930	SGISpro Additional Copy Software and Subscription	\$ 1,750.00
AGA5019	SGISpro Replacement	POA
523976	SGISpro Renewal Subscription	\$ 950.00
SGIS MAGNET Enterprise		
1003460-01	MAGNET Enterprise Ag Basic <i>1003460-01 includes:</i> <i>a licencse to access www.mobileagnetwork.com</i> <i>5GB of cloud storage</i> <i>first 12 months of use</i>	\$ 300.00
1003461-01	MAGNET Enterprise Ag Basic 12 Months Renewal	\$ 300.00

Note: In addition to logging into the website, the license can be used from other TPA tools such as
An X30, simply by logging in
SGIS, again by simply logging in
MAGNET Mobile Exchange for Ag - free Windows tablet app, available from Topcon Total Care

Training and Accessories

599909	Basic SGIS Training in Minnetonka, USA	\$ 750.00
599914	Advanced SGISpro Training in Minnetonka, USA	\$ 750.00
599915	On-Site SGIS Training	\$ 1,500.00
AGA5090	SGIS USB Memory Stick	\$ 35.00

Please note: above mentioned training prices do not include
airfares, travel or accomodation costs

Water Conservation



The New X30 console now offers Water Conservation incorporated via Topcon Horizon software. Other components include MC-R3 receiver, MC-A1 antenna as well as optional CR-G5 antenna, and availability as either single or dual scraper configurations. The Topcon MC-R3 contains GPS receivers, radio, and controllers in one rugged unit. A built-in MINTER panel provides status lights and function keys for easy performance verification and system checks.

Part Number	Description	USD List Price	
Console (all three components required)			
AGA4739	KIT X30 W/HARNESS	\$	5,995.00
1004746-01	HRNS PWR ADAPTOR 1.6m 2P DT TO 2P W/P	\$	100.00
1004052-01	WATER MANAGEMENT CODE FOR HORIZON BASED CONSOLE	\$	2,000.00

Note: currently requires SGR1 or AGI4 input. Future software builds will eliminate this requirement.

Note: for steering and leveling order 1003325-01 Kit, X30 AGI-4 instead of AGA4739 plus vehicle kit and suitable roof bracket

GPS Receivers and Options

Refer to Page: **27-28**

Options

AGA5310	Kit, X30 Console with Power Harness (Windows based software) Note: AGA5310 does not support VDC	\$	6,195.00
1005089-01	Kit VDC and Universal Bracket <i>1005089-01 kit contains:</i> <i>1003393-01 VDC Controller</i> <i>1004112-01 Harness VDC CAN/Power</i> <i>AGA5486 Kit, Mounting Bracket for VDC Controller</i>	\$	650.00



The VDC is designed to put selected display or console functions within easy reach of the operator

- * Hot Keys for rapid navigation
- * Scroll with rotary encoder
- * Select with push button
- * Easily adjust elevation or set points
- * Allows setting A-B point, mapping or engaging steering

Water Conservation



The MC-R3 features an Ethernet port, powerful processing capability and additional valve drivers for wide array of machine compatibility. Available with solid brackets for permanent mounting or magnetic mounting for portability.

The MC-A1 is a precision dual-frequency, dual constellation antenna featuring micro-center technology and an integrated ground plane to reduce multipath errors.

Step #1

Water Conservation Base Kit

USD List Price

Single Scraper Kits			
1600	KIT, Single Scraper W/O RADIO KIT	\$	10,300.00
1118	KIT, Single Scraper FH915 MC-A1	\$	12,995.00
1118-01	KIT, Single Scraper FH915 CR-G5	\$	15,495.00
1003938-01	KIT, Single Scraper DUHFII 413-430 MC-A1	\$	12,995.00
1003939-01	KIT, Single Scraper DUHFII 430-450 MC-A1	\$	12,995.00
1003937-01	KIT, Single Scraper DUHFII 450-470 MC-A1	\$	12,995.00
1003937-02	KIT, Single Scraper DUHFII 450-470 CR-G5	\$	15,495.00
Dual Scraper Kits			
1120	KIT, Dual Scraper FH915 MC-A1	\$	22,995.00
1120-01	KIT, Dual Scraper FH915 CR-G5	\$	27,995.00
1003935-01	KIT, Dual Scraper DUHFII 413-430 MC-A1	\$	22,995.00
1003936-01	KIT, Dual Scraper DUHFII 430-450 MC-A1	\$	22,995.00
1003934-01	KIT, Dual Scraper DUHFII 450-470 MC-A1	\$	22,995.00
1003934-02	KIT, Dual Scraper DUHFII 450-470 CR-G5	\$	27,995.00

Field Upgrades

1116	Single to Dual Scraper Field Upgrade Kit W/MC-A1	\$	12,500.00
1116-01	Single to Dual Scraper Field Upgrade Kit W/CR-G5	\$	14,500.00

Step #2

Single Scraper Kits

1150-21	CIH MX & STX	\$	1,400.00
1150-20	John Deere 8xxx/9xxx	\$	1,400.00
AGA4977	Single Load Sense Hydraulic	\$	3,250.00
AGA4978	Single Open Center Hydraulic	\$	4,500.00

Dual Scraper Kits

1150-23	Dual CIH MX & STX	\$	1,650.00
1150-22	Dual John Deere 8xxx/9xxx	\$	1,650.00
1004414-01	Dual Load Sense Hydraulic	\$	5,500.00
1004415-01	Dual Open Center Hydraulic	\$	6,600.00

Water Conservation

Step #3		USD List Price
Choose Front Scraper GPS Antenna Cable		
9063-1057-20Y	ASSY, RG213 N-Male/Female Yellow Cable 20'	\$ 305.00
9063-1057-25Y	ASSY, RG213 N-Male/Female Yellow Cable 25'	\$ 310.00
9063-1057-30Y	ASSY, RG213 N-Male/Female Yellow Cable 30'	\$ 315.00
9063-1057-35Y	ASSY, RG213 N-Male/Female Yellow Cable 35'	\$ 320.00
9063-1057-40Y	ASSY, RG213 N-Male/Female Yellow Cable 40'	\$ 325.00
9063-1057-45Y	ASSY, RG213 N-Male/Female Yellow Cable 45'	\$ 330.00
Step #4		
Choose Extension GPS Antenna Cable for Dual Set-up		
9063-1057-20	ASSY, RG213 N-Male Cable/Female Cable 20'	\$ 305.00
9063-1057-25	ASSY, RG213 N-Male Cable/Female Cable 25'	\$ 310.00
9063-1057-30	ASSY, RG213 N-Male Cable/Female Cable 30'	\$ 315.00
9063-1057-35	ASSY, RG213 N-Male Cable/Female Cable 35'	\$ 320.00
9063-1057-40	ASSY, RG213 N-Male Cable/Female Cable 40'	\$ 325.00
9063-1057-45	ASSY, RG213 N-Male Cable/Female Cable 45'	\$ 330.00
Step #5		
Choose Rear GPS Antenna Cable (Only for Dual Set-up)		
9063-1057-20	ASSY, RG213 N-Male Cable/Female Cable 20'	\$ 305.00
9063-1057-25	ASSY, RG213 N-Male Cable/Female Cable 25'	\$ 310.00
9063-1057-30	ASSY, RG213 N-Male Cable/Female Cable 30'	\$ 315.00
9063-1057-35	ASSY, RG213 N-Male Cable/Female Cable 35'	\$ 320.00
9063-1057-40	ASSY, RG213 N-Male Cable/Female Cable 40'	\$ 325.00
9063-1057-45	ASSY, RG213 N-Male Cable/Female Cable 45'	\$ 330.00
Step #6		
Add GPS Antenna Mounting Bracket (1 per each Antenna)		
9060-1402	KIT, 8.00 Flange to Post Bolt	\$ 32.00
9090-1435	POST, FIN 8.0 FLG to 1.75 DIA	\$ 600.00
9090-1440	POST, FIN 8.00 FLG TO 2.00	\$ 475.00

Water Conservation

AGForm-3D Landforming Survey and Design Kit

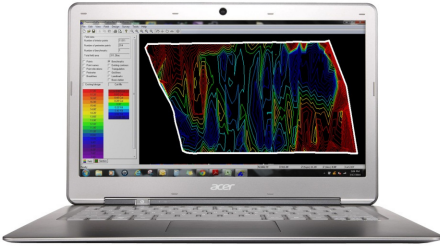

AGForm-3D state-of-the-art Survey and Design software coupled with Hiper V or GR-5 GPS receivers is used for independent survey of your field and creating a flat, single/dual slope or multi slope design without leaving your vehicle. Note: each sold copy of AGForm-3D comes with one software license that can be used for an office or field computer.

Survey and Design Kit - Landforming

1003316-03	KIT, AG SURVEY AND DESIGN HIPER V 915+	\$ 23,990.00
	1003316-01 KIT, HIPER V AG BASE 915+	
	1003316-02 KIT, HIPER V AG ROVER 915+	
	22-050908-01 POLE, 2M FIXED HT RANGE (GNSS)	
	320600101 TRIPOD TP-100 EXT LEG 5/8-11QR	
	51779 PRISM POLE BIPOD 3/4"-1 1/4"	
	7040-0051 Kit, AgForm 3D Survey / Design Software	
1003317-03	KIT, AG SURVEY AND DESIGN GR5 915+	\$ 29,500.00
	1003317-01 KIT, GR5 AG BASE Kit 915+	
	1003317-02 KIT, GR5 AG ROVER Kit 915+	
	22-050908-01 POLE, 2M FIXED HT RANGE (GNSS)	
	320600101 TRIPOD TP-100 EXT LEG 5/8-11QR	
	51779 PRISM POLE BIPOD 3/4"-1 1/4"	
	7040-0051 Kit, AgForm 3D Survey / Design Software	
1003319-01	Kit, AG,HiPerV DUAL DUHF2 450-470	\$ 23,990.00
	1001856-07 ASSY,HiPer V,DUHF II, NO BOX,NFS Quantity 2	
	22-050908-01 POLE, 2M FIXED HT RANGE (GNSS)	
	320600101 TRIPOD TP-100 EXT LEG 5/8-11QR	
	51779 PRISM POLE BIPOD 3/4"-1 1/4"	
	7040-0051 Kit, AgForm 3D Survey / Design Software	
1003319-02	Kit, AG,HiPerV DUAL DUHF2 400-430	\$ 23,990.00
	1001856-07 ASSY,HiPer V,DUHF II, NO BOX,NFS Quantity 2	
	22-050908-01 POLE, 2M FIXED HT RANGE (GNSS)	
	320600101 TRIPOD TP-100 EXT LEG 5/8-11QR	
	51779 PRISM POLE BIPOD 3/4"-1 1/4"	
	7040-0051 Kit, AgForm 3D Survey / Design Software	
1003319-03	Kit, AG,HiPerV DUAL DUHF2 430-450	\$ 23,990.00
	1001856-07 ASSY,HiPer V,DUHF II, NO BOX,NFS Quantity 2	
	22-050908-01 POLE, 2M FIXED HT RANGE (GNSS)	
	320600101 TRIPOD TP-100 EXT LEG 5/8-11QR	
	51779 PRISM POLE BIPOD 3/4"-1 1/4"	
	7040-0051 Kit, AgForm 3D Survey / Design Software	

Water Conservation

Options

1003348-01	OAF-U, HiPer V, GGD 10 Hz, AG	\$	3,000.00
1003350-01	OAF-U, GR-5, GGD 10 Hz, AG	\$	3,000.00
1003316-01	KIT, HIPER V AG BASE 915+	\$	8,950.00
1003316-02	KIT, HIPER V AG ROVER 915+	\$	11,950.00
1003317-01	KIT, GR5 AG BASE Kit 915+	\$	11,950.00
1003317-02	KIT, GR5 AG ROVER Kit 915+	\$	14,950.00
7040-0051	Kit, AgForm 3D Survey / Design Software 1 license per copy	\$	3,000.00

Tripods

320628121	TP-210T/PS, Aluminum Tripod	\$	115.00
1004396-01	Topcon Fiberglass Tripod w/ Dual Clamp	\$	130.00
59010	TP-10 WOOD EXT LEG	\$	295.00

Slope Laser



RL-200 Series Single and Dual Slope Lasers

The Topcon RL-200 Series sets new standards for simplicity and accuracy. Rugged, lightweight, and compact, for twice the laser at an amazingly affordable price.

Choose from two models, RL-200 1S single slope, or RL-200 2S dual slope. The RL-200 1S provides single slope from -5% up to +25%. The RL-200 2S provides dual slopes up to +/-10% in the X axis, or up to an industry-leading -5 to +25% in the Y axis.

Part Numbers	Description	USD List Price	
Slope Kits			
314910702	RL-200 1S DB (Single Slope - Dry Cell Batteries)	\$	2,995.00
314910762	RL-200 1S RB (Single Slope - Rechargeable Batteries)	\$	3,295.00
314920722	RL-200 2S DB (Dual Slope - Dry Cell Batteries)	\$	3,495.00
314920742	RL-200 2S RB (Dual Slope - Rechargeable Batteries)	\$	4,295.00
Tripods			
320628121	TP-210T/PS, Aluminum Tripod	\$	115.00
1004396-01	Topcon Fiberglass Tripod w/ Dual Clamp	\$	130.00
59010	TP-10 WOOD EXT LEG	\$	295.00

9164 AG System Five



Elevation control for two scrapers - or slope and elevation on a single scraper.
Combine with TM-1 survey masts or use rigid masts for economy.

Part Number	Description	USD List Price
CHOOSE SYSTEM BASE KIT		
5700V	BASE KIT, 9164 Single AG System V	\$ 7,995.00
5701V	BASE KIT, 9164 Dual AG System V	\$ 15,995.00
5702V	BASE KIT, 9164 Single AG System V, Short TM-1	\$ 9,995.00
5703V	BASE KIT, 9164 Dual AG System V, Short TM-2	\$ 15,995.00
5704V	BASE KIT, 9164 Single AG, OEM Valves	\$ 9,720.00
5705V	BASE KIT, 9164 Dual AG, OEM Valves	\$ 15,295.00
5706V	BASE KIT, 9164 Single AG, OEM Valves, Short TM-1	\$ 9,720.00
5707V	BASE KIT, 9164 Dual AG, OEM Valves, Short TM-2	\$ 15,295.00
CHOOSE MACHINE CONTROL SPECIFIC KIT		
5720V	KIT, 9164 SYS V JD 8000 SCV	\$ 1,200.00
5721V	KIT, 9164 SYS V JD 9000 SCV	\$ 1,200.00
5722V	KIT, 9164 SYS V CASE MX MAGNUM	\$ 1,200.00
5723V	KIT, 9164 SYS V CASE STX	\$ 1,200.00
5724V	KIT, 9164 SYS V LOAD SENSE TRACTOR	\$ 5,500.00
5725V	KIT, 9164 SYS V SENSE ARTICULATED TRACTOR	\$ 5,500.00
5726V	KIT, 9164 SYS V OPEN CENTRE ARTICULATED TRACTOR	\$ 6,600.00
5727V	KIT, 9164 SYS V OPEN CENTER TRACTOR	\$ 6,600.00
CHOOSE SCRAPER CABLE		
9063-1004-15	ASSY, Cable CB-Mast 15'	\$ 325.00
9063-1004-20	ASSY, Cable CB-Mast 20'	\$ 350.00
9063-1004-25	ASSY, Cable CB-Mast 25'	\$ 375.00
9063-1004-30	ASSY, Cable CB-Mast 30'	\$ 425.00
9063-1004-35	ASSY, Cable CB-Mast 35'	\$ 450.00
CHOOSE EXTENSION CABLE ONLY IF REAR SCRAPER WILL BE AUTOMATED		
9063-1003-10	ASSY, Cable CB-Mast 10'	\$ 400.00
9063-1003-15	ASSY, Cable CB-Mast 15'	\$ 425.00
9063-1003-20	ASSY, Cable CB-Mast 20'	\$ 475.00
9063-1003-25	ASSY, Cable CB-Mast 25'	\$ 500.00
9063-1003-30	ASSY, Cable CB-Mast 30'	\$ 525.00
9063-1003-35	ASSY, Cable CB-Mast 35'	\$ 550.00
9063-1003-45	ASSY, Cable CB-Mast 45'	\$ 600.00
CHOOSE EXTENSION CABLE ONLY IF REAR SCRAPER WILL BE AUTOMATED		
9063-1005-20	ASSY, 11P-11S Rear TM1 Cable 20'	\$ 375.00
9063-1005-25	ASSY, 11P-11S Rear TM1 Cable 25'	\$ 400.00
9063-1005-35	ASSY, 11P-11S Rear TM1 Cable 35'	\$ 450.00
9063-1005-45	ASSY, 11P-11S Rear TM1 Cable 45'	\$ 550.00
9063-1005-55	ASSY, 11P-11S Rear TM1 Cable 55'	\$ 600.00
CHOOSE TM-1 MOUNTING OPTION		
9060-1289	KIT, Fixed Position TM-1 Plate	\$ 99.00
9060-1290	KIT, 3" Tube Clamp	\$ 135.00
9060-1292	KIT, Post 3.0" Bolt on Mast	\$ 395.00
9222-1046	KIT, TM-1 6X6 Mount	\$ 255.00

9256 AG System Five



Combine with a TM-1 mast and LS-B110 laser receiver for automatic control and survey capabilities on a single scraper. Survey function adds, then averages elevations. Perfect for field leveling or maintaining roads or ditch pads.

Part Number	Description	USD List Price
CHOOSE SYSTEM BASE KIT		
5207V	KIT, AG Single System V Base	\$ 7,995.00
5208V	KIT, AG Single System V Short TM1	\$ 7,995.00
CHOOSE MACHINE CONTROL SPECIFIC KIT		
5220V	KIT, 9256 SYS V JD 8000 SCV	\$ 1,000.00
5221V	KIT, 9256 SYS V JD 9000 SCV	\$ 1,000.00
5222V	KIT, 9256 SYS V CASE MX MAGNUM	\$ 1,000.00
5223V	KIT, 9256 SYS V CASE STX	\$ 1,000.00
5224V	KIT, 9256 SYS V LOAD SENSE TRACTOR	\$ 3,250.00
5225V	KIT, 9256 SYS V SENSE ARTICULATED TRACTOR	\$ 3,250.00
5226V	KIT, 9256 SYS V OPEN CENTRE ARTICULATED TRACTOR	\$ 4,500.00
5227V	KIT, 9256 SYS V OPEN CENTER TRACTOR	\$ 4,500.00
CHOOSE SCRAPER CABLE		
9063-1004-15	ASSY, Cable CB-Mast 15'	\$ 325.00
9063-1004-20	ASSY, Cable CB-Mast 20'	\$ 350.00
9063-1004-25	ASSY, Cable CB-Mast 25'	\$ 375.00
9063-1004-30	ASSY, Cable CB-Mast 30'	\$ 425.00
9063-1004-35	ASSY, Cable CB-Mast 35'	\$ 450.00
CHOOSE EXTENSION CABLE ONLY IF REAR SCRAPER WILL BE AUTOMATED		
9063-1003-10	ASSY, Cable CB-Mast 10'	\$ 400.00
9063-1003-15	ASSY, Cable CB-Mast 15'	\$ 425.00
9063-1003-20	ASSY, Cable CB-Mast 20'	\$ 475.00
9063-1003-25	ASSY, Cable CB-Mast 25'	\$ 500.00
9063-1003-30	ASSY, Cable CB-Mast 30'	\$ 525.00
9063-1003-35	ASSY, Cable CB-Mast 35'	\$ 550.00
9063-1003-45	ASSY, Cable CB-Mast 45'	\$ 600.00
CHOOSE TM-1 MOUNTING OPTION		
9060-1289	KIT, Fixed Position TM-1 Plate	\$ 99.00
9060-1290	KIT, 3" Tube Clamp	\$ 135.00
9060-1292	KIT, POST 3.0" Bolt on Mast	\$ 395.00
9222-1046	KIT, TM-1 6X6 Mount	\$ 255.00

Spray Control for System 200



As the industry leader in precision spraying, Topcon X20 Sprayer Control features the ability to simultaneously handle up to three tanks, dual line, boom control and control of up to 30 boom sections, all from a single console.

The Sprayer Kits consist of sprayer ECU, sprayer application software, switch box and all required harnesses.

X20 Console, Flow Meter or Valves are not included

Part Number	Description	USD List Price
Sprayer Interface Kits - X20 Not Included		
A2781	Upto 7 Sections - Single Line: 2 Wire Motor Valves - 7.5 Mtrs Harness	\$ 5,000.00
A2778	Upto 7 Sections - Single Line: 3 Wire Motor Valves - 7.5 Mtrs Harness	\$ 5,000.00
A2779	7 + 7 Sections - Dual Line: 3 Wire Motor Valves - 7.5 Mtrs Harness	\$ 6,000.00
Self Propelled Sprayer Interface Kits - X20 Not Included		
A2461	ROGATOR 1254 / 64 / 74 & 7000 Series Spray Coupes	\$ 4,000.00
A2900	SPRA COUPE 3000/4000 Series ASC /Product Control Kit	\$ 3,500.00
A3219	Sprayer Interface Kit to suit SPRA COUPE 7000 Series	\$ 3,750.00
A2385	ZYNX Interface Kit to suit Bateman SP Sprayer	\$ 3,500.00
A2573	Self Propelled kit to suit JD 4910 / 4920 SP Sprayer (ASC ONLY)	\$ 3,500.00
A3107	X20 Spray ECU Kit to suit CASE 4410/4420/4260C SPX SP	\$ 3,500.00
A3004	ZYNX Interface Kit to suit Miller	\$ 3,500.00
Existing Controller Retrofit Kits		
A931H	HARDI Pilot 6 Sections Interface includes Hardware Kit	\$ 4,750.00
A2254	ARAG BRAVO 300	\$ 3,500.00
A2951	FARMSCAN 24V1 (ASC Only)	\$ 3,500.00
A2791	RAVEN 440 / 4400	\$ 4,000.00
A1857	TEE-JET 844 CONTROLLER (ROUND PLUG ONLY)	\$ 3,500.00
A1858	TEE-JET 855 CONTROLLER	\$ 3,750.00
A1859	MICRO-TRAK MT3000 Controller	\$ 3,500.00
A1860	MICRO-TRAK MT3405 Controller	\$ 3,750.00
A1861	MICRO-TRAK MT9000 Controller	\$ 3,500.00
A1787	HARDI 5500 - 8 SECTIONS SINGLE LINE ONLY	\$ 3,500.00
A1793	HARDI 2500 - 3 SECTIONS ONLY	\$ 3,500.00
Options		
A1268	Sprayer Switch Box 6 Section	\$ 960.00
A1679	Software Maplink Multilayer CD Package	\$ 800.00

Seeder Control for System 200



The X20 Seeder Controller handles up to 5 different products including granular, liquid and NH3. This gives the X20 powerful multitasking ability to seed, provide steering assist with full guidance, and variable rate control for all bins.

The following kit prices are for standard installation air seeders.

X20 Console is NOT included

Part Number	Description	USD List Price	
Seeding Control Kits - X20 Kit NOT Included			
AGA3877	2 Tank Seeder Controller Kit ~ Tow Behind	\$	7,300.00
AGA3892	3 Tank Seeder Controller Kit ~ Tow Behind	\$	8,030.00
AGA3894	4 Tank Seeder Controller Kit ~ Tow Behind	\$	8,755.00
A1462	2 Tank Topcon Universal Electric Seeder	\$	13,680.00
A1463	3 Tank Topcon Universal Electric Seeder	\$	17,040.00
Options			
A1267	Seeder Interface Switch Box	\$	900.00
A1679	Software Maplink Multilayer CD Package	\$	800.00

Spreader Control for System 200



X20 Spreader Control from Topcon Precision Agriculture is a full-featured controller with variable rate control and mapping capabilities

Functions of Spreader Kits are limited to equipment on Spreader.

X20 Console is NOT included

Part Number	Description	USD List Price	
Spreader Control Kits			
A2598	Spreader Control Reg Drive Kit (Spinner + Belt)	\$	2,500.00
A2599	Spreader Control Proportional Drive Kit (Spinner + Belt)	\$	2,500.00

Ag Cam for X20



The X20 Ag Cam System from Topcon is a leader in providing high quality images. View inputs from up to four vehicle mounted video cameras on the same X20 console used for all other precision agriculture functions. Providing high-quality images in a variety of lighting conditions, the X20 Ag Cam gives the operator improved machine control, better safety, and monitoring. The X20 Ag Cam uses a unique camera engineered to reliably withstand harsh environments. Featuring a completely waterproof housing, hi-resolution color and infrared processing, the X-20 Ag Cam can be used in a variety of farming applications.

Part Numbers	Description	USD List Price
AgCam Kits		
A3274	X20 AgCam Interface Kit	\$ 1,700.00
	<i>A3274 Kit contains:</i>	
A3358	AGCAM INTERFACE COMPLETE	
A3360	AGCAM POWER HARNESS 5 METRES	
A3366	H/DUTY USB CABLE W/P B TO A 5m	
A1953	POWER ADAPTOR/SPLITTER HARNESS	
A3393	AGCAM SINGLE CAMERA KIT WITH	
A3275	AGCAM OPERATION/INSTALLATION	
Option		
A3393	X20 AgCam Single Camera Kit	\$ 800.00

CropSpec for X20

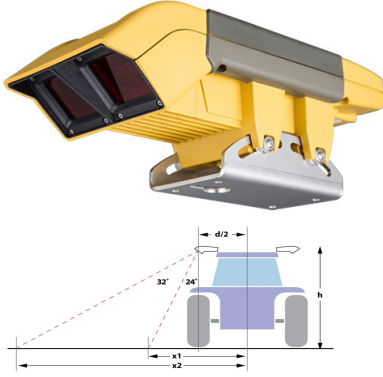

Topcon CropSpec Crop Canopy Sensors were co-developed with Yara, a world leading manufacturer of fertilizers. CropSpec sensors, mounted on the vehicle roof deliver data day and night to the display. Crop N readings can be mapped every time a vehicle travels the field, providing invaluable crop data. Alternatively, utilize display XLinks, or application functionalities so the sensors are able to not only read the N requirements but also provide variable rate application, all in the one field pass.

Note: Only series 2 X20 consoles work with CropSpec

Part Number	Description	USD List Price
-------------	-------------	----------------

X20 CropSpec Kits

AGA3839	CropSpec with 2 Sensors Kit <i>AGA3839 Kit contains:</i> 319000101 CROPSPEC SENSOR AGA3835 CROPSPEC HARNESS KIT AGA3841 CROPSPEC QUICK REF GUIDE AGA3861 CROPSPEC QUICK MOUNT ADAPT AGA3842 CROPSPEC INSTALLATION SHEET	\$ 19,500.00
AGA5048	CropSpec with 1 Sensor Kit <i>AGA5048 Kit contains:</i> 319000101 CROPSPEC SENSOR AGA3835 CROPSPEC HARNESS KIT AGA3861 CROPSPEC QUICK MOUNT ADAPT AGA5093 CROPSPEC INSTALLATION GUIDE	\$ 11,000.00

System X20 Application Software and Xlinks

Part Number	Description	USD List Price	
Software			
A1679	MAPLINK MULTILAYER SOFTWARE	\$	800.00
A1547	MAPLINK LITE SOFTWARE	\$	400.00
A1004	FULL GUIDANCE - included with X20 Console		
A1595	PRO STEER - included with Pro Steer ECU		
XLink			
Existing Spray Rate Controllers			
A1970	To suit EAGLE Sprayer with ASC	\$	800.00
A1864	To suit HARDI Mustang with ASC	\$	800.00
A2941	5500 / 6500 with	\$	800.00
A1865	To suit RAVEN 440 Spray Controller (No ASC)	\$	800.00
Existing Seed Rate Controllers			
A2593	To suit EAGLE Seeder with ASC	\$	800.00
A1853	To suit Flexicoil 50 Series Air Cart	\$	800.00
A1863	To suit Rawson Seed Rate Controller	\$	800.00
Existing Spreader Controllers			
A1866	To suit Transpread	\$	1,500.00
SW0009	To Suit Bogballe	\$	1,500.00
SW0010	To Suit Kverneland	\$	1,500.00
SW0011	To Suit Amazone	\$	1,500.00
SW0012	To Suit Vicon	\$	1,500.00



Topcon Precision Agriculture
16900 West 118th Terrace
Olathe, KS 66061 USA
Phone: 866-486-7266

Topcon Precision Agriculture
14 Park Way
Mawson Lakes SA 5095 Australia
Phone: +61-8-8203-3300
Fax : +61-8-8203-3399

Topcon Precision Agriculture
Avenida de la Industria 35
Tres Cantos 28760, Spain
Phone: +34-91-804-92-31
Fax: +34-91-803-14-15

Topcon Positioning Systems, Inc.
7400 National Drive
Livermore CA 94551 USA
Phone: 925-245-8300
Fax: 925-245-8599

Topcon Corporation
75-1 Hasunuma-cho, Itabashi-ku
Tokyo 174-8580 Japan
Phone: +81-3-5994-0671
Fax: +81-3-5994-0672

© 2014 Topcon Precision Agriculture
All rights reserved
Specifications subject to change without notice